

HIGH PRESSURE REGULATORS

	DESCRIPTION	Kv:	SUPPLY PRESSURE	PRESSURE RANGE	CONNECTION	DEVICE	PAGE
			max. bar	bar	thread		
PRESS. REGULATOR	also for liquids and O ₂	0.3 - 25.6	40	0.2 ... 3 / 35	G ₁ / ₄ - G ₂	R280	4.02
	for many different gases	0.2 - 70	50	0.1 ... 1.5 / 50	G ₁ / ₈ - G ₄	R120	4.04
	also for liquids	1.3 - 3.2	60	0.5 ... 12 / 50	G ₁ / ₄ - G ₁	R286	4.08
	low cost	0.02	207	0.1 ... 3.5 / 12	1/4"NPT	RH83	4.09
	for many different gases	0.05 - 3.5	200	0.1 ... 1.5 / 200	G ₁ / ₄ - G ₁ / ₄	RH10	4.10
	gas cylinder pressure regulator		200	0 ... 1.5 / 40	DIN 477	RH201, RH202	4.12
	gas cylinder pressure regulator		300	0 ... 1.5 / 40	DIN 477	RH300	4.13
	gas cylinder pressure regulator		100	0 ... 10 / 60	G ₁ / ₄ - G ₁ / ₂	RH-147	4.14
	gas cylinder pressure regulator		200	0 ... 10 / 60	G ₁ / ₄ - G ₁ / ₂	RH-247	4.14
	gas cylinder pressure regulator		300	0 ... 10 / 60	G ₁ / ₄ - G ₁ / ₂	RH-347	4.14
	miniature	0.05	241	0.2 ... 2 / 7	1/8"NPT and 1/4"NPT	RH0	4.15
	miniature	0.05	414	0.5 ... 5 / 124	1/4"NPT	RH1	4.15
	for pure gases 5.0	0.9	207	0.2 ... 1.7 / 14	3/8"NPT and 1/2"NPT	RH2	4.16
	different pressure ranges	0.05	414	0.3 ... 35 / 414	1/4"NPT	HP300	4.17
	made of brass	0.05	414	0.7 ... 104 / 172	1/4"NPT	HP400	4.17
	different pressure ranges	0.05	300	0.1 ... 1.7 / 35	1/4"NPT	HP500	4.18
	large nominal size	1.7	260	0.7 ... 21 / 104	1/2"NPT and 3/4"NPT	RH3	4.19
	large nominal size	1.7	345	0.7 ... 21 / 172	1/2"NPT and 3/4"NPT	RH3-U	4.19
	made of brass	0.3	414	0 ... 14 / 28	3/8"NPT and 1/2"NPT	RH4	4.20
	different pressure ranges	0.05	1 034	0.3 ... 35 / 690	1/4"NPT	HP306	4.21
MADE OF SST	for many different gases	0.05 - 3.5	200	1 ... 8 / 200	G ₁ / ₄ - G ₁ / ₄	RH3000	15.16
	large nominal size	1.7	310	0.7 ... 21 / 104	1/2"NPT and 3/4"NPT	RH3-S1	4.19
	robust	0.13	380	0.3 ... 2 / 35	1/4"NPT	RHB-S	www
	large nominal size	1.7	410	0.7 ... 21 / 172	1/2"NPT and 3/4"NPT	RH3-S2	4.19
	different pressure ranges		690	0.3 ... 35 / 414	1/4"NPT	HP300-S	4.17
	for different gases, wide variety		60	0.1 ... 1.5 / 50	G ₁ / ₈ - G ₂	R3000	15.06
VACUUM REGULATOR	made of brass		4	0.06...1 bar _{abs}	1/4"NPT	RDV	www
DIFFERENTIAL PRESS.	brass or stainless steel	0.7 / 2.0	414	0 ... 1 / 24	1/2"NPT and 3/4"NPT	RH44	4.22
VOLUME BOOSTER	ratio 1:2 to 1:19	1.7	260	3 ... 42 / 104	1/2"NPT and 3/4"NPT	RH3-J	6.14
	SST 1:2 to 1:19	1.7	310	3 ... 42 / 104	1/2"NPT and 3/4"NPT	RH3-JS1	6.14
	SST	2.9	100	0.1 ... 24 / 99	G ₁	RLM, RLE	6.16
	made of brass		50	1 ... 15 / 50	G ₁ / ₄ - G ₂	R120-J	6.17

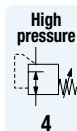

Description	Diaphragm pressure regulator for supply pressure up to 40 bar, of solid design, completely made of brass.
Media	compressed air, non-corrosive gases or liquids. Regulator R280-16 is not suitable for liquids.
Supply pressure	max. 40 bar, for liquids $\Delta P_{max.} = 25$ bar
Adjustment	by handwheel for G $\frac{1}{4}$ and G $\frac{1}{2}$, with locknut by T-handle for G $\frac{3}{4}$ up to G1 $\frac{1}{2}$ by knob for G2 by hexagonal spindle for range 0.5...16/25 bar, up to size G $\frac{1}{2}$ 14 mm A/F, otherwise 19 mm A/F
Relieving function	relieving, optionally non-relieving
Gauge port	G $\frac{1}{4}$ on both sides of the body, one screw plug supplied
Mounting position	any
Temperature range	-10 °C to 90 °C / 14 °F to 194 °F
Material	Body: brass, aluminium die-cast at G2 regulator Elastomer: NBR/Buna-N Inner valve: brass

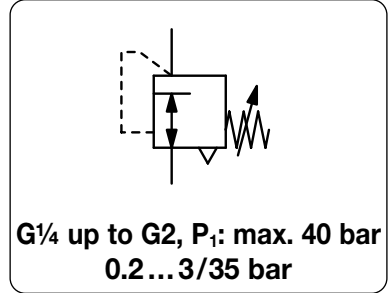

Dimensions			Pressure adjustment	K _v -value	Flow-rate	Connection thread	Pressure range	Order number
A	B	C	mit	(m ³ /h)	m ³ /h*1	G	bar	B*
mm	mm	mm			l/min*1			

Brass pressure regulator			supply pressure max. 40 bar, for compressed air relieving, without pressure gauge				R280		
45	104	23	handwheel	0.3	26	430	G $\frac{1}{4}$	0.2... 3	R280-02A
								0.2... 6	R280-02B
								0.5... 10	R280-02C
								0.5... 16	R280-02D
								0.5... 25	R280-02E
72	145	30	handwheel	0.8	75	1250	G $\frac{1}{2}$	0.2... 3	R280-04A
								0.2... 6	R280-04B
								0.5... 10	R280-04C
								0.5... 16	R280-04D
								0.5... 25	R280-04E
			hexagonal spindle						
95	216	41	T-handle	4.8	450	7500	G $\frac{3}{4}$ *2	0.2... 3	R280-06A
								0.2... 6	R280-06B
								0.5... 10	R280-06C
								0.5... 16	R280-06D
								0.5... 25	R280-06E
			hexagonal spindle						
95	216	41	T-handle	5.0	468	7800	G1	0.2... 3	R280-08A
								0.2... 6	R280-08B
								0.5... 10	R280-08C
								0.5... 16	R280-08D
								0.5... 25	R280-08E
			hexagonal spindle						
128	240	50	T-handle	7.1	660	11000	G1 $\frac{1}{4}$ *2	0.2... 3	R280-10A
								0.2... 6	R280-10B
								0.5... 10	R280-10C
								0.5... 16	R280-10D
								0.5... 25	R280-10E
			hexagonal spindle						

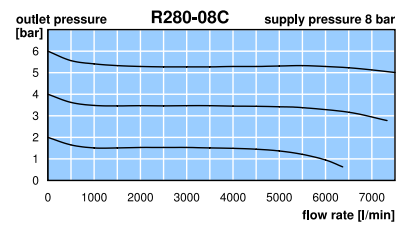
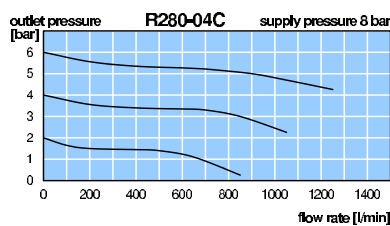
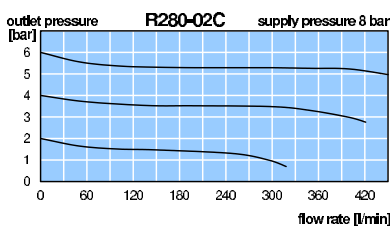
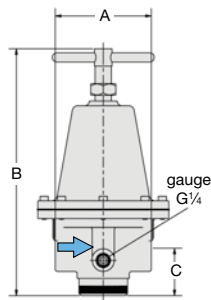
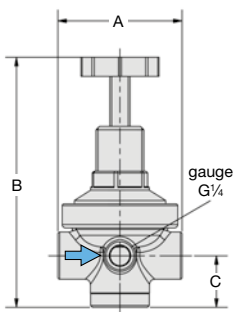

*1 at 8 bar supply pressure, 6 bar outlet pressure and 1 bar pressure drop

*2 reduced from next bigger thread

* Product group

PDF CAD
www.aircom.net



Order example:
R280-02A

Description	Diaphragm pressure regulator for supply pressure up to 40 bar, of solid design, completely made of brass.
Media	compressed air, non-corrosive gases or liquids. Regulator R280-16 is not suitable for liquids.
Supply pressure	max. 40 bar, for liquids $\Delta P_{max.} = 25$ bar
Adjustment	by handwheel for G $\frac{1}{4}$ and G $\frac{1}{2}$, with locknut by T-handle for G $\frac{3}{4}$ up to G1 $\frac{1}{2}$ by knob for G2
Relieving function	relieving, optionally non-relieving
Gauge port	G $\frac{1}{4}$ on both sides of the body, one screw plug supplied
Mounting position	any
Temperature range	-10 °C to 90 °C / 14 °F to 194 °F
Material	Body: brass, aluminium die-cast at G2 regulator Elastomer: NBR/Buna-N Inner valve: brass

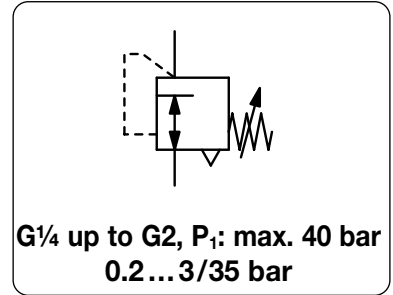

Dimensions			Pressure adjustment	K _v -value	Flow-rate	Connection thread	Pressure range	Order number
A	B	C	mit	(m ³ /h)	m ³ /h*1	l/min*1	G	bar

Brass pressure regulator								supply pressure max. 40 bar, for compressed air relieving, without pressure gauge	R280
114	240	50	T-handle	7.7	720	12000	G1 $\frac{1}{2}$	0.2... 3	R280-12A
								0.2... 6	R280-12B
								0.5... 10	R280-12C
			hexagonal spindle					0.5... 16	R280-12D
								0.5... 25	R280-12E
160	248	78	knob	25.6	2400	40000	G2	0.5... 6	R280-16B
								0.5... 10	R280-16C
								0.5... 16	R280-16D
								0.5... 25	R280-16E
								0.5... 35	R280-16F



Special options, add the appropriate letter			
non-relieving for oxygen	without relieving function	not for G2	R280-... K
	specially cleaned, with oxygen grease, max. 60 °C/140 °F	up to G1 $\frac{1}{2}$	R280-... K15

Accessories, enclosed			
pressure gauge	Ø 50 mm, 0... *2 bar, G $\frac{1}{4}$	for G $\frac{1}{4}$ and G $\frac{1}{2}$	MA5002- . *2
	Ø 50 mm, 0... 25 bar, G $\frac{1}{4}$	for G $\frac{1}{4}$ and G $\frac{1}{2}$	MA5002- 25
	Ø 63 mm, 0... *2 bar, G $\frac{1}{4}$	from G $\frac{3}{4}$	MA6302- . *2
	Ø 63 mm, 0... 25 bar, G $\frac{1}{4}$	from G $\frac{3}{4}$	MA6302- 25
mounting bracket	made of steel	for G $\frac{1}{4}$	BW20-03
mounting nut	made of brass	for G $\frac{1}{4}$	M20x1,5M
mounting bracket	made of steel	for G $\frac{1}{2}$	BW28-01
mounting nut	made of brass	for G $\frac{1}{2}$	M28x1,5M
mounting bracket	made of steel	for G $\frac{3}{4}$ to G1 $\frac{1}{2}$	BW00-39
mounting bracket	made of steel	for G2	BW00-40

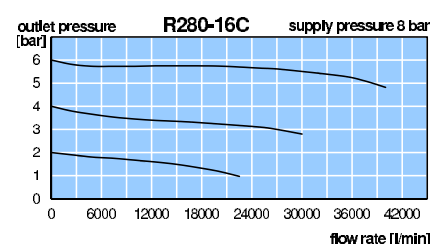
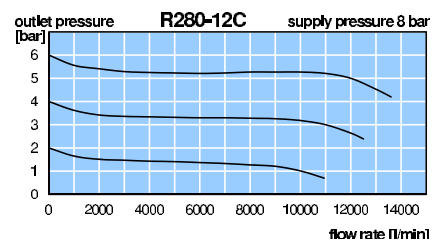
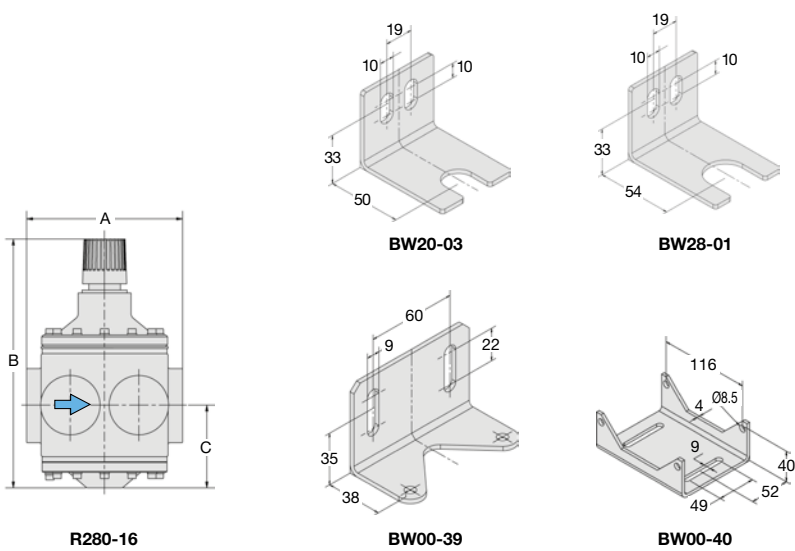

*1 at 8 bar supply pressure, 6 bar outlet pressure and 1 bar pressure drop
*2 04 = 0...4 bar, 06 = 0...6 bar, 10 = 0...10 bar, 16 = 0...16 bar

Description	Pressure regulator of solid design. Made of brass or bronze. Series R120-0..A to -0..E and R120-16 and -32 are equipped with diaphragms, all other are piston-operated.
Media	compressed air, non-corrosive gases or liquids
Adjustment	Supply pressure see chart, max. 50 bar, for liquids $\Delta p_{max} = 25$ bar R120-01/-A2: with adjusting screw, at R120-02 with black knob R120-04 to -B6: with T-handle R120-16: with hexagonal spindle (spanner size 24 mm) R120-16/-24/-32: by pilot pressure regulator
Relieving function	R120-B6: relieving R120-16/-24/-32: non-relieving
Gauge port	R120-01/-A2: G $\frac{3}{8}$ on both sides of the body, all others G $\frac{1}{4}$ on both sides of the body, one screw plug supplied
Temperature range	Mounting position any 0 °C bis 80 °C / 32 °F to 176 °F, for appropriately conditioned compressed air down to -20 °C / -4 °F or low temperature version down to -40 °C / -40 °F, optionally high temperature version up to 130 °C / 266 °F
Material	Body: brass O-ring: FKM, optionally EPDM Spring cage: brass at R120-01 to -04, aluminum at R120-06 to -32 Inner valve: brass Diaphragm: NBR/Buna-N with PTFE coating

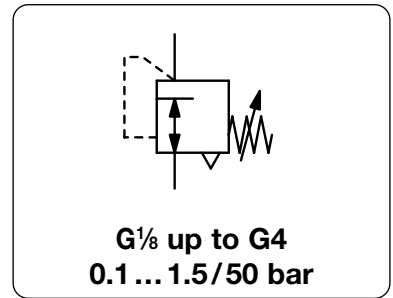

Dimensions			Regul. system	K _v -	Flow	Connection	P ₁	Pressure	Order
A	B	C	D: diaphragm	value	rate	thread	max.	range	number
mm	mm	mm	P: piston	(m ³ /h)	m ³ /h*1	G	bar	bar	

Brass pressure regulator										R120
for compressed air, supply pressure max. 30 / 50 bar, relieving, without pressure gauge										
40	88	18	D	0.35	8	130	G $\frac{3}{8}$	30	0.1 ... 1.5	R120-01A
			D		10	160		30	0.2 ... 3.0	R120-01B
			D		15	250		30	0.5 ... 8.0	R120-01C
			D		20	330		30	1 ... 15	R120-01E
40	88	18	D	0.35	8	130	G $\frac{1}{4}$	30	0.1 ... 1.5	R120-A2A
			D		10	160		30	0.2 ... 3.0	R120-A2B
			D		15	250		30	0.5 ... 8.0	R120-A2C
			D		20	330		30	1 ... 15	R120-A2E
69	146	35	D	1.4	16	260	G $\frac{1}{4}$	30	0.1 ... 1.5	R120-02A
			D		20	320		30	0.2 ... 3.0	R120-02B
			D		30	500		30	0.5 ... 8.0	R120-02C
			D		40	660		50	1 ... 15	R120-02E
69	161	35	P		50	840		50	2 ... 30	R120-02F
			P		60	1000		50	3 ... 50	R120-02G
69	146	35	D	0.35	16	260	G $\frac{3}{8}$	30	0.1 ... 1.5	R120-03A
			D		20	320		30	0.2 ... 3.0	R120-03B
			D		30	500		30	0.5 ... 8.0	R120-03C
			D		40	660		50	1 ... 15	R120-03E
69	161	35	P		50	840		50	2 ... 30	R120-03F
			P		60	1000		50	3 ... 50	R120-03G



Special options and Accessories, see separate page

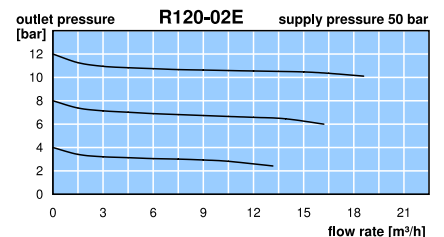
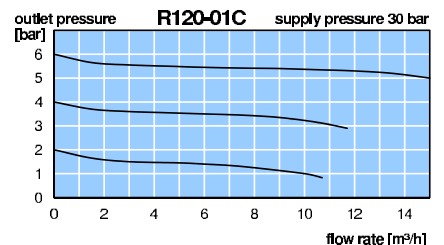
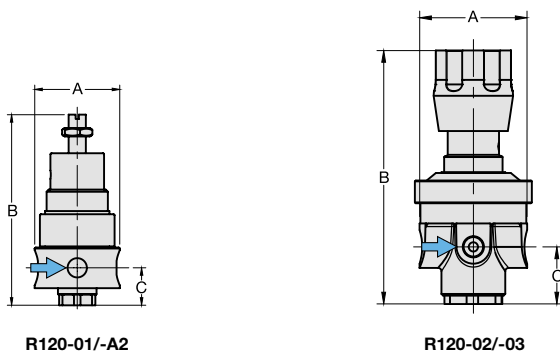

*1 at max. supply pressure and max. outlet pressure

* Product group

Gauges: see chapter for measuring devices

PDF CAD
www.aircom.net



Order example:
R120-01A

Description Pressure regulator of solid design. Made of brass or bronze. Series R120-0..A to -0..E and R120-16 and -32 are equipped with diaphragms, all other are piston-operated.

Media compressed air, non-corrosive gases or liquids **Supply pressure** see chart, max. 50 bar, for liquids $\Delta p_{max} = 25$ bar

Adjustment R120-01/-A2: with adjusting screw, at R120-02 with black knob
 R120-04 to -B6: with T-handle R120-16: with hexagonal spindle (spanner size 24 mm)
 R120-16/-24/-32: by pilot pressure regulator

Relieving function R120-16/-24/-32: non-relieving

Gauge port R120-01/-A2: G $\frac{1}{8}$ on both sides of the body, all others G $\frac{1}{4}$ on both sides of the body, one screw plug supplied

Temperature range 0 °C bis 80 °C / 32 °F to 176 °F, for appropriately conditioned compressed air down to -20 °C / -4 °F or low temperature version down to -40 °C / -40 °F, optionally high temperature version up to 130 °C / 266 °F

Material Body: brass
 O-ring: FKM, optionally EPDM
 Spring cage: brass at R120-01 to -04, aluminum at R120-06 to -32
 Inner valve: brass
 Diaphragm: NBR/Buna-N with PTFE coating

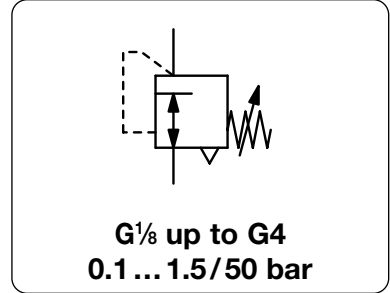

Dimensions			Regul. system	K _v -	Flow	Connection	P ₁	Pressure	Order
A	B	C	D: diaphragm	value	rate	thread	max.	range	number
mm	mm	mm	P: piston	(m ³ /h)	m ³ /h*1	G	bar	bar	

Brass pressure regulator			for compressed air, supply pressure max. 30 / 50 bar, relieving, without pressure gauge						R120	
78	171	37	D	3.0	27	450	G $\frac{1}{2}$	30	0.1 ... 1.5	R120-04A
				30	600	30	0.2 ... 3.0	R120-04B		
				40	830	30	0.5 ... 8.0	R120-04C		
				60	1250	50	1 ... 15	R120-04E		
78	171	37	P	100	2080	50	2 ... 30	R120-04F		
				120	2500	50	3 ... 50	R120-04G		
114	290	66	D	9.8	75	1250	G $\frac{3}{4}$ *2	30	0.1 ... 1.5	R120-06A
				98	1600	30	0.2 ... 3.0	R120-06B		
				170	2800	30	0.5 ... 8.0	R120-06C		
				280	4600	50	1 ... 15	R120-06E		
114	315	66	P	400	6600	50	2 ... 30	R120-06F		
				500	8300	50	3 ... 50	R120-06G		
114	290	66	D	9.8	75	1250	G1	30	0.1 ... 1.5	R120-08A
				98	1600	30	0.2 ... 3.0	R120-08B		
				170	2800	30	0.5 ... 8.0	R120-08C		
				280	4600	50	1 ... 15	R120-08E		
114	315	66	P	400	6600	50	2 ... 30	R120-08F		
				500	8300	50	3 ... 50	R120-08G		

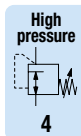

Special options and Accessories, see separate page

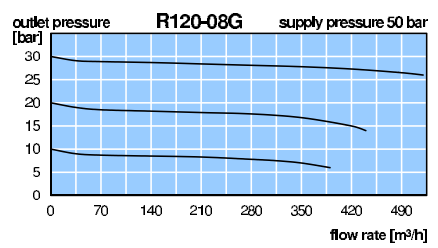
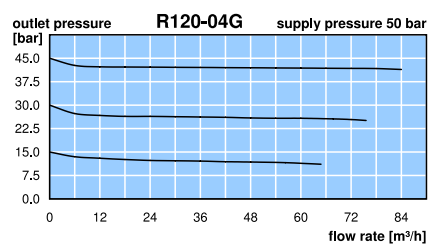
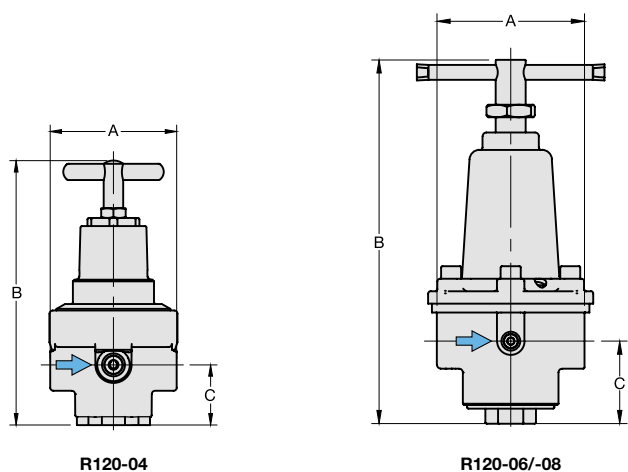

*1 at max. supply pressure and max. outlet pressure
 *2 reduced from next bigger thread

Gauges: see chapter for measuring devices

PDF CAD
 www.aircom.net

* Product group
 Order example:
R120-04A

Description	Pressure regulator of solid design. Made of brass or bronze. Series R120-0..A to -0..E and R120-16 and -32 are equipped with diaphragms, all other are piston-operated.
Media	compressed air, non-corrosive gases or liquids
Adjustment	Supply pressure see chart, max. 50 bar, for liquids $\Delta p_{max} = 25$ bar R120-01/-A2: with adjusting screw, at R120-02 with black knob R120-04 to -B6: with T-handle R120-16: with hexagonal spindle (spanner size 24 mm) R120-16/-24/-32: by pilot pressure regulator
Relieving function	R120-B6: relieving R120-16/-24/-32: non-relieving
Gauge port	R120-01/-A2: G $\frac{1}{8}$ on both sides of the body, all others G $\frac{1}{4}$ on both sides of the body, one screw plug supplied
Temperature range	Mounting position any 0 °C bis 80 °C / 32 °F to 176 °F, for appropriately conditioned compressed air down to -20 °C / -4 °F or low temperature version down to -40 °C / -40 °F, optionally high temperature version up to 130 °C / 266 °F
Material	Body: brass O-ring: FKM, optionally EPDM Spring cage: brass at R120-01 to -04, aluminum at R120-06 to -32 Inner valve: brass Diaphragm: NBR/Buna-N with PTFE coating

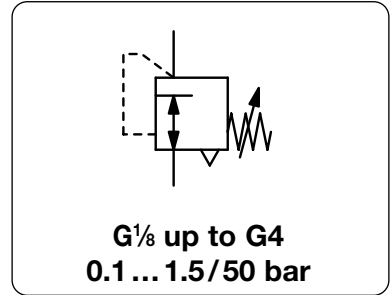

Dimensions			Regul. system	K _v -	Flow	Connection	P ₁	Pressure	Order
A	B	C	D: diaphragm	value	rate	thread	max.	range	number
mm	mm	mm	P: piston	(m ³ /h)	m ³ /h*1	G	bar	bar	

Brass pressure regulator										R120
										for compressed air, supply pressure max. 30 / 50 bar, relieving, without pressure gauge
174	386	122	P	25	400	6600	G1½	30	0.1 ... 1.5	R120-12A
			P		670	11000		30	0.2 ... 3.0	R120-12B
			P		1000	16600		30	0.5 ... 8.0	R120-12C
			P		1500	25000		50	1 ... 15	R120-12E
			P		1600	27000		50	2 ... 30	R120-12F
			P		2000	33000		50	3 ... 50	R120-12G
174	386	122	P	25	400	6600	G2	30	0.1 ... 1.5	R120-B6A
			P		670	11000		30	0.2 ... 3.0	R120-B6B
			P		1000	16600		30	0.5 ... 8.0	R120-B6C
			P		1500	25000		50	1 ... 15	R120-B6E
			P		1600	27000		50	2 ... 30	R120-B6F
			P		2000	33000		50	3 ... 50	R120-B6G
180	421	128	D	25	1800	30000	G2	30	0.1 ... 1.5	R120-16AK
			D		2100	35000		30	0.2 ... 3.0	R120-16BK
			D		2500	40000		30	0.3 ... 6.0	R120-16CK
180	403	128	D		3500	50000		30	1 ... 15	R120-16DK
389	434	118	D	65	2400	40000	flange	30	0.1 ... 1.5	R120-24AKF
			D		5000	83000		30	0.2 ... 3.0	R120-24BKF
			D		5000	83000	DN80	30	0.3 ... 6.0	R120-24CKF
			D		6000	99000		30	1 ... 15	R120-24DKF
389	434	118	D	65	2400	40000	flange	30	0.1 ... 1.5	R120-32AKF
			D		3700	61000		30	0.2 ... 3.0	R120-32BKF
			D		5000	83000	DN100	30	0.3 ... 6.0	R120-32CKF
			D		6000	99000		30	1 ... 15	R120-32DKF



R120-12/-B6



R120-16DK

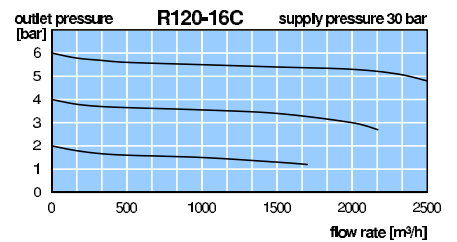
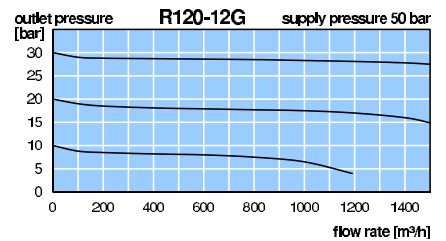
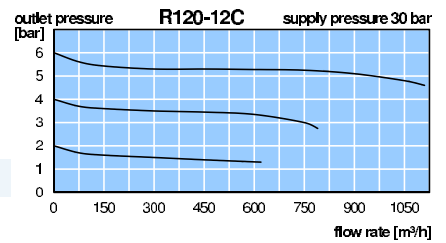

Special options and Accessories, see separate page

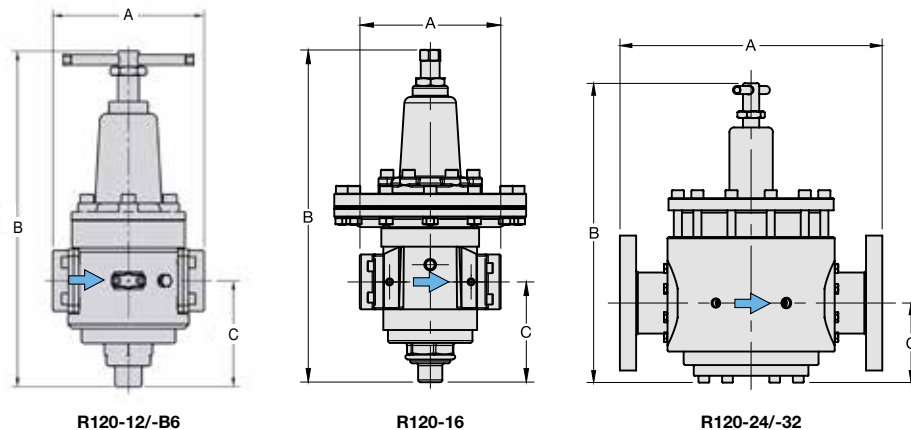

*1 at max. supply pressure and max. outlet pressure

* Product group

Gauges: see chapter for measuring devices

PDF CAD
www.aircom.net



Order example:
R120-12A

Description	Pressure regulator of solid design. Made of brass or bronze. Series R120-0..A to -0..E and R120-16 and -32 are equipped with diaphragms, all other are piston-operated.
Media	compressed air, non-corrosive gases or liquids Supply pressure see chart, max. 50 bar, for liquids $\Delta p_{max} = 25$ bar
Adjustment	R120-01/-A2: with adjusting screw, Supply pressure at R120-02 with black knob R120-04 to -B6: with T-handle R120-16: with hexagonal spindle (spanner size 24 mm) R120-16/-24/-32: by pilot pressure regulator
Relieving function	R120-B6: relieving R120-16/-24/-32: non-relieving
Gauge port	R120-01/-A2: G $\frac{1}{8}$ on both sides of the body, all others G $\frac{1}{4}$ on both sides of the body, one screw plug supplied
Temperature range	0 °C bis 80 °C / 32 °F to 176 °F, for appropriately conditioned compressed air down to -20 °C / -4 °F or low temperature version down to -40 °C / -40 °F, optionally high temperature version up to 130 °C / 266 °F
Material	Body: brass O-ring: FKM, optionally EPDM Spring cage: brass at R120-01 to -04, aluminum at R120-06 to -32 Inner valve: brass Diaphragm: NBR/Buna-N with PTFE coating

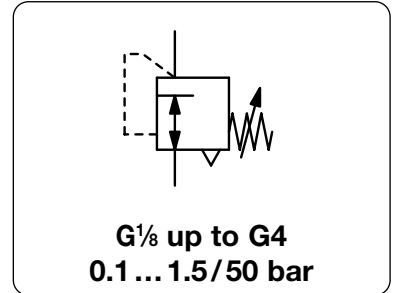

Dimensions			Regul. system	K _v -	Flow	Connection	P ₁	Pressure	Order
A	B	C	D: diaphragm	value	rate	thread	max.	range	number
mm	mm	mm	P: piston	(m ³ /h)	m ³ /h*1	l/min*1	G	bar	bar

Special options, add the appropriate letter

NPT	connection thread			R120-...N
non-relieving	without relieving function		up to R120-B6	R120-...K
down to -40 °C	low temperature version			R120-...X51
up to 130 °C	high temperature version			R120-...X54
Spring cage made of POM	for G $\frac{1}{8}$ and G $\frac{1}{4}$ (A2)			R120-...X57
EPDM O-ring	PTFE diaphragm			R120-...E
T-handle	instead of plastic knob		for R120-02	R120-02..T
PWIS-free	for painting plants			R120-...LA
carbon dioxide	CO ₂			R120-...K03
argon	Ar			R120-...K05
nitrogen	N ₂			R120-...K07
helium	He			R120-...K09
hydrogen	H ₂			R120-...K11
methane	CH ₄			R120-...K13
natural gas *3				R120-...K14
oxygen	O ₂			R120-...K15
propane	C ₃ H ₈			R120-...K16
nitrous oxide	N ₂ O			R120-...K17
water	H ₂ O			R120-...KW
flange connection	standard for R120-32, otherwise see chapter SST devices /flanges			R120-...F.

Accessories, enclosed

pressure gauge	Ø 40 mm, 0...*2 bar, G $\frac{1}{8}$	for G $\frac{1}{8}$ and G $\frac{1}{4}$ (A2)	MA4001-...*2
	Ø 50 mm, 0...*2 bar, G $\frac{1}{4}$	for G $\frac{1}{4}$ (02) up to G $\frac{1}{2}$	MA5002-...*2
	Ø 50 mm, 0...60 bar, G $\frac{1}{4}$	for G $\frac{1}{4}$ up to G $\frac{1}{2}$	MA5002-60
	Ø 63 mm, 0...*2 bar, G $\frac{1}{4}$	for G $\frac{3}{4}$ up to G4	MA6302-...*2
	Ø 63 mm, 0...60 bar, G $\frac{1}{4}$	for G $\frac{3}{4}$ up to G4	MA6302-60
gauge up to 130 °C	Ø 63 mm, 0...*2 bar, G $\frac{1}{4}$, stainless steel		MS6302-...*2
mounting bracket	made of stainless steel	for G $\frac{1}{8}$ u. G $\frac{1}{4}$ (A2)	BW30-03S
mounting nut	made of stainless steel	for G $\frac{1}{8}$ and G $\frac{1}{4}$ (A2)	M30x1,5SS
mounting bracket	made of stainless steel	for G $\frac{1}{4}$ (02) and G $\frac{3}{8}$	BW35-01S
mounting nut	made of stainless steel	for G $\frac{1}{4}$ (02) and G $\frac{3}{8}$	M35x1,5S
mounting bracket	made of stainless steel	for G $\frac{1}{2}$	BW50-01S
mounting nut	made of stainless steel	for G $\frac{1}{2}$	M50x1,5S
mounting bracket	made of steel	for G $\frac{3}{4}$ and G1	BW00-42
		for G1 $\frac{1}{2}$ and G2 (B6)	BW00-68S

*1 at max. supply pressure and max. outlet pressure
*2 02 = 0...2.5 bar, 04 = 0...4 bar, 06 = 0...6 bar, 10 = 0...10 bar, 16 = 0...16 bar

*3 without DVGW approval

* Product group

Gauges: see chapter for measuring devices

PDF CAD
www.aircom.net



Order example:
MA4001-02

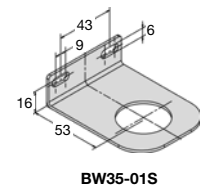

BW35-01S

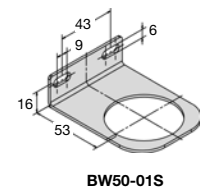

BW50-01S

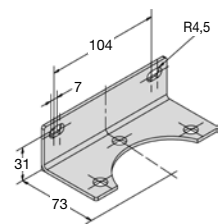

BW00-42

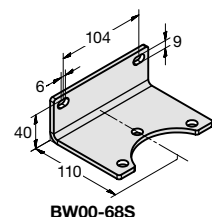

BW00-68S

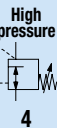

Description	Piston-operated pressure regulator of solid design, completely made of brass. For inlet pressure up to 60 bar.		
Media	compressed air, non-corrosive gases or liquids		
Supply pressure	max. 60 bar, for liquids $\Delta p_{max.} = 25$ bar		
Adjustment	by handwheel, T-handle or hexagonal spindle, with locknut		
Relieving function	relieving, optionally non-relieving		
Gauge port	G $\frac{1}{4}$ on both sides of the body, one screw plug supplied		
Mounting position	any	Inlet filter	stainless steel, 500 μ m
Temperature range	-10 °C to 90 °C / 14 °F to 194 °F		
Material	Body: brass Elastomer: NBR/Buna-N	Intermediate ring: brass at G $\frac{1}{4}$, anodized aluminium at G1 Inner valve: brass	

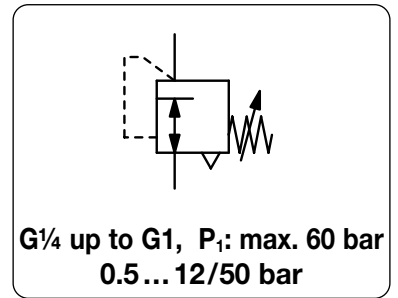

Dimensions			Pressure adjustment	K $_v$ -value	Flow rate	Connection thread	Pressure range	Order number
A	B	C	mit	(m 3 /h)	m 3 /h*1	G	bar	B*
mm	mm	mm			l/min*1			

Brass pressure regulator			supply pressure max. 60 bar, for compressed air relieving, without pressure gauge				R286		
72	164	31	handwheel	1.3	120	2000	G $\frac{1}{4}$	0.5 ... 12	R286-02C
			hexagonal spindle					1.0 ... 20	R286-02E
								2.0 ... 35	R286-02F
								3.0 ... 50	R286-02G
72	164	31	handwheel	1.6	150	2500	G $\frac{3}{8}$	0.5 ... 12	R286-03C
			hexagonal spindle					1.0 ... 20	R286-03E
								2.0 ... 35	R286-03F
								3.0 ... 50	R286-03G
72	156	35	handwheel	2.3	216	3500	G $\frac{1}{2}$	0.5 ... 12	R286-04C
			hexagonal spindle					1.0 ... 20	R286-04E
								2.0 ... 35	R286-04F
								3.0 ... 50	R286-04G
118	257	51	handwheel	3.2	300	5000	G1	0.5 ... 12	R286-08C
			hexagonal spindle					1.0 ... 20	R286-08E
								2.0 ... 35	R286-08F
								3.0 ... 50	R286-08G



Special options, add the appropriate letter

non-relieving without relieving function, for liquids R286-0 . . K

Accessories, enclosed

pressure gauge	\varnothing 50 mm, 0...10 bar, G $\frac{1}{4}$	for G $\frac{1}{4}$ to G $\frac{1}{2}$	MA5002- 10
	0...25 bar, G $\frac{1}{4}$	for G $\frac{1}{4}$ to G $\frac{1}{2}$	MA5002- 25
	0...60 bar, G $\frac{1}{4}$	for G $\frac{1}{4}$ to G $\frac{1}{2}$	MA5002- 60
	\varnothing 63 mm, 0...16 bar, G $\frac{1}{4}$	for G1	MA6302- 16
	0...25 bar, G $\frac{1}{4}$	for G1	MA6302- 25
	0...60 bar, G $\frac{1}{4}$	for G1	MA6302- 60
mounting bracket	made of steel, mounting nut required	for G $\frac{1}{4}$ to G $\frac{1}{2}$	BW28-01
mounting nut	made of brass	for G $\frac{1}{4}$ to G $\frac{1}{2}$	M28x1,5M
mounting bracket	made of steel, assembly at spring cage	for G1	BW00-45

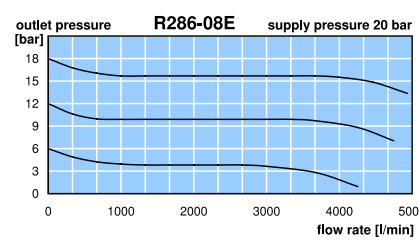
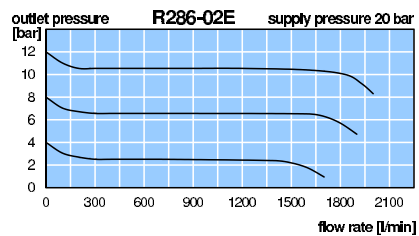
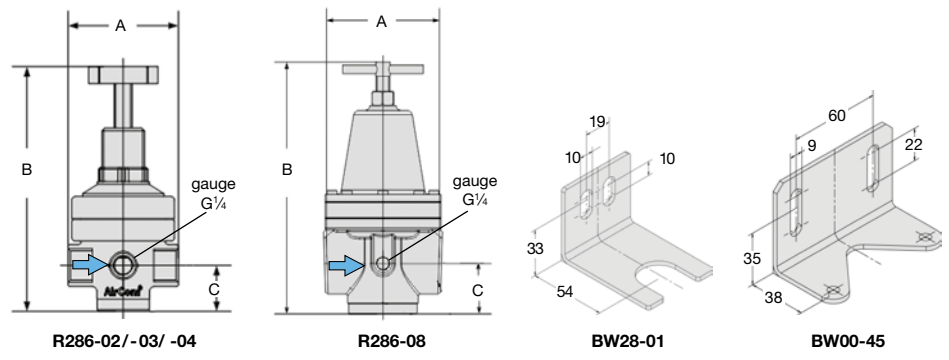

*1 at 20 bar supply pressure, 10 bar outlet pressure and 4 bar pressure drop

* Product group

Gauges: see chapter for measuring devices **PDF CAD** www.aircom.net

Order example: R286-02C

Description	Diaphragm-operated high pressure regulator made of brass .		
Media	compressed air, nitrogen, helium, krypton, carbon dioxide, neon, xenon		
Supply pressure	max. 207 bar		
Adjustment	by slotted screw with locknut		
Relieving function	standard, optionally non-relieving		
Connection thread	¼" NPT, two high pressure inlet ports and two regulated pressure outlet ports.		
Mounting position	any		
Temperature range	-34 °C to 60 °C / -29.2 °F to 140 °F		
Material	Body: brass	Diaphragm: NBR/Buna-N and acetal	Seals: NBR/Buna-N
	Spring cage: zinc die-cast	Valve seat: teflon, brass and stainless steel	

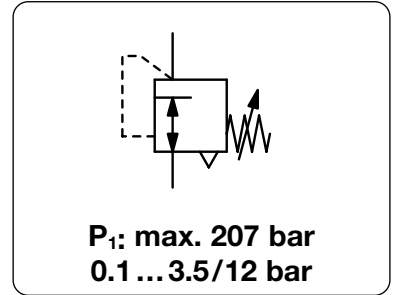

Dimensions			K _v -value (m ³ /h)	Flow rate		Connection thread NPT	Pressure range bar	Order number	D*
A	B	C		m ³ /h*1	l/min*1				

High pressure regulator 207 bar				for compressed air, relieving made of brass, NBR/Buna-N		RH83		
48	110	10	0.02	19.2	320	¼" NPT	0.1 ... 3.5	RH83-02A
							0.3 ... 8.5	RH83-02B
							0.7 ... 12	RH83-02C

Special options, add the appropriate letter

non-relieving	without relieving function	RH83-02. K
carbon dioxide	CO ₂	RH83-02. K03
argon	Ar	RH83-02. K05
nitrogen	N ₂	RH83-02. K07
helium	He	RH83-02. K09
inert gas	krypton, neon, xenon	RH83-02. K31



RH83

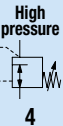

Accessories, enclosed

pressure gauge	Ø 50 mm, ¼" NPT	MA5002- ..*N
----------------	-----------------	--------------

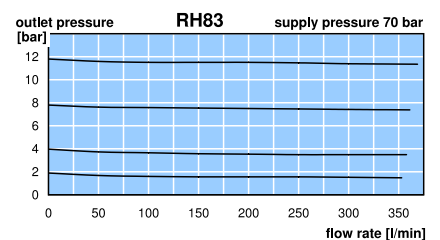
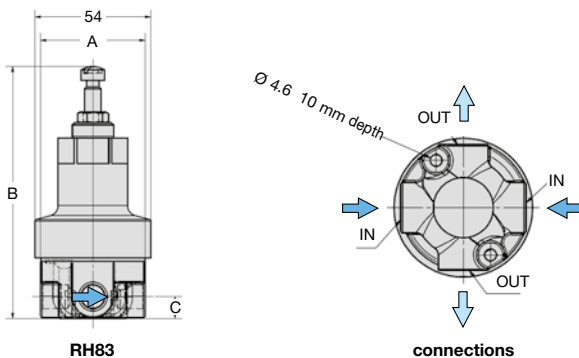

*1 bei P₁ = 70 bar, P₂ = 4 bar und Δp = 0.35 bar

*2 04 = 0...4 bar, 11 = 0...11 bar, 16 = 0...16 bar

* Product group



Description For outlet pressures up to 15 bar the regulator has a diaphragm, for higher outlets a piston.
A sintered bronze filter at the inlet port protects against contamination.

Media compressed air or non-corrosive gases

Supply pressure max. 220 bar

Adjustment RH10-02: by black plastic knob all others: by T-handle with locknut

Gauge port All regulators are equipped with both one supply pressure gauge and one outlet pressure gauge.

Safety relief valve prevents from overpressure, see chart

Compensation All regulators are equipped with supply pressure variation compensation, so that a change in supply pressure has no effect on the outlet pressure's stability.

Temperature range -20 °C to 60 °C / -4 °F to 140 °F

Material Body: brass, nickel-plated at RH10-02
Piston: brass at RH10-02
Valve seat: nylon
Diaphragm: stainless steel at RH10-02, NBR/Buna-N at all others

Mounting position any
Inlet filter: sintered bronze
O-rings: EPDM or FKM, dependent on media

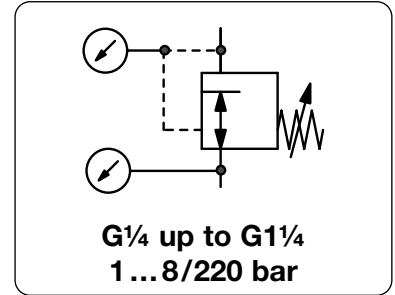

Dimensions			Safety	K _v -	Flow	Connection	Pressure	Order
A	B	C	relief valve	value	rate	thread	range	number
mm	mm	mm	S: with valve	(m ³ /h)	m ³ /h*1 l/min*1	inlet / outlet	bar	

High pressure regulator 220 bar							non-relieving, for compressed air, pressure gauges supplied	RH10	
176	145	35	S	0.05	80	1300	DIN 477 / G _{1/4} f	1 ... 8	RH10-02A
			S					1 ... 15	RH10-02B
176	163	35	S					3 ... 30	RH10-02C
			S					5 ... 50	RH10-02D
			S					10 ... 100	RH10-02E
			-					20 ... 200	RH10-02F
184	176	40	S	0.19	228	3800	DIN 477 / G _{3/8} f	0.1 ... 1.5	RH10-030
			S					1 ... 15	RH10-03B
			S					3 ... 30	RH10-03C
			S					5 ... 50	RH10-03D
184	186	40	-					10 ... 100	RH10-03E
			-					20 ... 200	RH10-03F
182	245	102	S	0.25	422	7000	G _{3/4} f / G _{3/4} m	0.1 ... 1.5	RH10-A30
			S					1 ... 15	RH10-A3B
182	260	102	S					3 ... 30	RH10-A3C
			S					5 ... 50	RH10-A3D
182	195	35	-					10 ... 100	RH10-A3E
			-					20 ... 200	RH10-A3F
166	345	232	S	0.6	2000	33000	G _{3/4} a / G _{3/4} m	1 ... 8	RH10-06A
			S					1 ... 15	RH10-06B
166	358	245	S					3 ... 30	RH10-06C
			S					5 ... 50	RH10-06D
			-					10 ... 100	RH10-06E
253	370	242	S	1.8	3000	48000	G ₁ m / G ₁ m	1 ... 8	RH10-08A
			S					1 ... 15	RH10-08B
253	406	278	S					3 ... 30	RH10-08C
			S					5 ... 50	RH10-08D
253	406	278	-					20 ... 200	RH10-08F

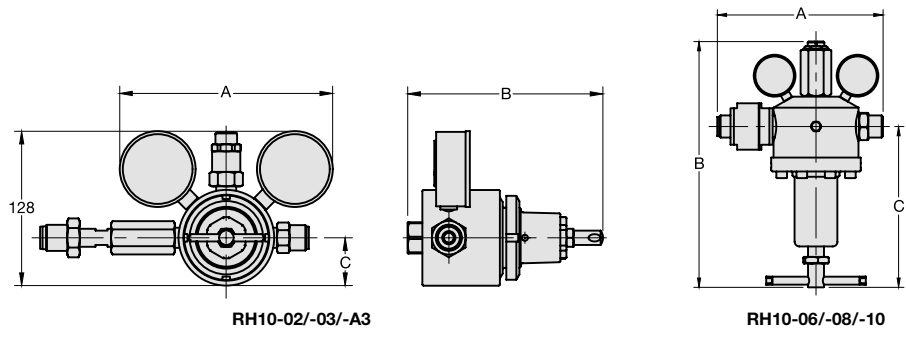
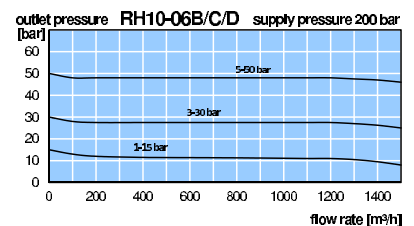
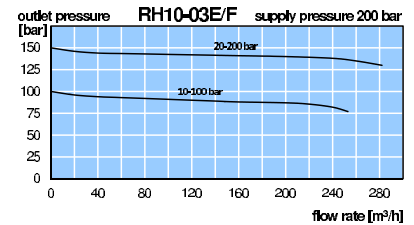
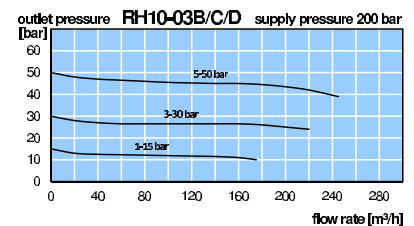

*1 at 200 bar supply pressure and 15 bar outlet pressure *2 max. 80 bar outlet pressure

HIGH PRESSURE REGULATOR FOR OUTLET PRESSURE UP TO 200 BAR

RH10

Description	For outlet pressures up to 15 bar the regulator has a diaphragm, for higher outlets a piston. A sintered bronze filter at the inlet port protects against contamination.	
Media	compressed air or non-corrosive gases	
Supply pressure	max. 220 bar	
Adjustment	RH10-02: by black plastic knob	all others: by T-handle with locknut
Gauge port	All regulators are equipped with both one supply pressure gauge and one outlet pressure gauge.	
Safety relief valve	prevents from overpressure, see chart	
Compensation	All regulators are equipped with supply pressure variation compensation, so that a change in supply pressure has no effect on the outlet pressure's stability.	
Temperature range	-20 °C to 60 °C / -4 °F to 140 °F	
Material	Body: brass, nickel-plated at RH10-02 Piston: brass at RH10-02 Valve seat: nylon Diaphragm: stainless steel at RH10-02, NBR/Buna-N at all others	Mounting position any Inlet filter: sintered bronze O-rings: EPDM or FKM, dependent on media

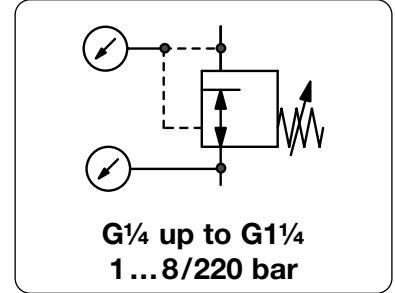

Dimensions			Safety relief valve	K _v -value	Flow rate	Connection thread	Pressure range	Order number
A	B	C	S: with valve	(m³/h)	m³/h*1	inlet / outlet	bar	

High pressure regulator 220 bar								non-relieving, for compressed air, pressure gauges supplied	RH10
248	385	270	S	3.1	5000	80000	G1m / G1¼	1... 8	RH10-10A
			S					1... 15	RH10-10B
			S					3... 30	RH10-10C
248	420	305	S					5... 50	RH10-10D



Special options, add the appropriate letter

relieving	with relieving function, for compressed air	RH10-...R
FKM elastomer		RH10-...V
PTFE elastomer		RH10-...T
SST diaphragm	from RH10-03	RH10-...S
for panel mounting	for RH10-02 to -A3	RH10-...P
carbon dioxide *2	CO ₂	RH10-...03
argon	Ar	RH10-...05
nitrogen	N ₂	RH10-...07
helium	He	RH10-...09
hydrogen	H ₂	RH10-...11
methane	CH ₄	RH10-...13
oxygen	O ₂	RH10-...15
propane	C ₃ H ₈	RH10-...16
nitrous oxide	N ₂ O	RH10-...17
without cylinder connection		RH10-...X40

Accessories, enclosed

mounting bracket	made of stainless steel	for RH10-02	BW35-01S
mounting nut		for RH10-02	M35x1,5S
mounting bracket		for RH10-03 and -A3	BW50-01S
mounting nut		for RH10-03 and -A3	M50x1,5S
mounting bracket		for RH10-06	BW00-31S
		for RH10-08	BW00-35S

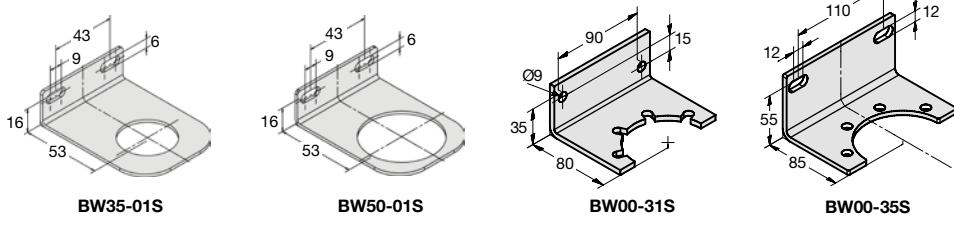
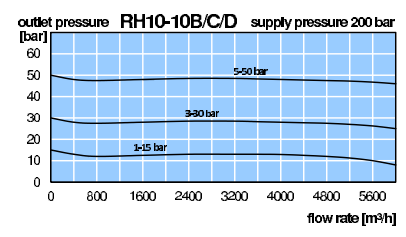
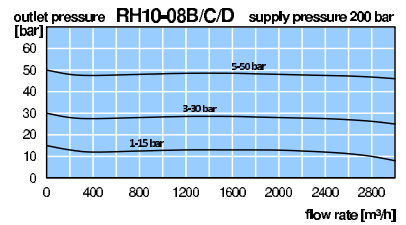

*1 at 200 bar supply pressure max. outlet pressure *2 max. 80 bar outlet pressure

Stainless steel version: see chapter for stainless steel devices

PDF CAD
www.aircom.net

Order example: RH10-10A

Description	High pressure regulator for gas cylinders for reducing pressure of compressed air or liquid gases from a high level to the required pressure.		
Supply pressure	max. 200 bar		
Media	compressed air, oxygen or different gases		
Connections	according to DIN 477 (Part 1)		
Adjustment	by T-handle		
Gauge port	All regulators are equipped with both one supply pressure gauge and one outlet pressure gauge.		
Leakage rate	10 ⁻⁸ mbar l/s		
Compensation	All regulators are equipped with supply pressure variation compensation, so that a change in supply pressure has no effect on the outlet pressure's stability.		
Temperature range	-30 °C to 60 °C / -22 °F to 140 °F		
Material	Body: brass	O-rings: NBR/Buna-N and EPDM	Spring cage: brass
	Diaphragm: 65NBR4550, PTFE for outlet > 10 bar, stainless steel for pure gases up to 5.0		

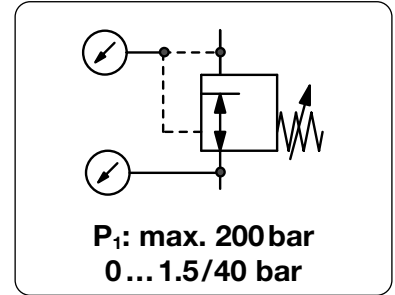

Dimensions			Version	Flow rate	Supply pressure	Pressure range	Order number
A	B	C	1-step	m ³ /h*2	l/min*2	max. bar	
mm	mm	mm	2-step			bar	

Cylinder pressure regulator 200 bar for compressed air, connections DIN 477, RH201/RH202 with inlet / outlet gauges

210	190	100	1-step	48	800	200	0 ... 10	RH201-00C
210	210	120		75	1250		0 ... 20	RH201-00D
				120	2000		0 ... 40	RH201-00E
240	190	100	2-step	8	133	200	0 ... 15	RH202-00A
				48	800		0 ... 10	RH202-00C



RH201, 1-step

Regulator for propane and acetylene connections DIN 477, RH201 with inlet / outlet gauges

210	190	100	1-step	propane	C ₃ H ₈	max. 8	0 ... 4.0	RH201-00B16
210	190	100	1-step	acetylene	C ₂ H ₂	max. 26	0 ... 1.5	RH201-00A19

Special options, change the appropriate letter

carbon dioxide	CO ₂	RH20 .-... 03
inert gas		RH20 .-... 04
argon	Ar	RH20 .-... 05
fuel gas		RH20 .-... 06
nitrogen	N ₂	RH20 .-... 07
forming gas		up to 40 bar RH20 .-... 08
helium	He	up to 40 bar RH20 .-... 09
hydrogen	H ₂	RH20 .-... 11
testing gas		up to 40 bar RH20 .-... 12
oxygen	O ₂	up to 40 bar RH20 .-... 15
chrome-plated body	inside and outside	1-step RH201 -C...
chrome-plated body	inside and outside	2-step RH202 -C...
metal diaphragm	5.0 purity	1-step RH201 - .M...
		2-step RH202 - .M...



RH202, 2-step

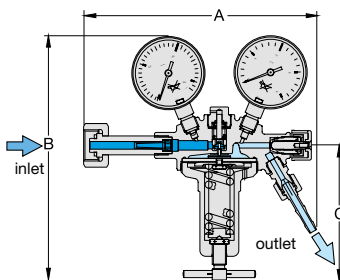

cross-section, 1-step

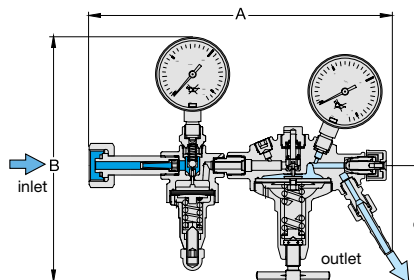

cross-section, 2-step



RH201-C..., chrome-plated

connection thread up to 200 bar		
gas type	inlet *1	outlet
compressed air	G ³ / ₈ m	G ¹ / ₄
oxygen	G ³ / ₈ f	G ¹ / ₄
inert gas	W21, 8x ¹ / ₄	G ¹ / ₄
CO ₂ / argon	W21, 8x ¹ / ₄	G ¹ / ₄
helium	W21, 8x ¹ / ₄	G ¹ / ₄
fuel gas	W21, 8x ¹ / ₄ LH	G ³ / ₈ LH
hydrogen	W21, 8x ¹ / ₄ LH	G ³ / ₈ LH
forming gas	W21, 8x ¹ / ₄ LH	G ³ / ₈ LH

connection thread up to 200 bar		
gas type	inlet *1	outlet
nitrogen	W24,32x ¹ / ₄	G ¹ / ₄
testing gas	M19x1,5 LH	G ³ / ₈ LH
nitrous oxide	G ³ / ₈	G ¹ / ₄
acetylene	clamp (cylinder)	G ³ / ₈ a LH

flow rate - correction factor	
gas type	factor
compr. air	1.00
oxygen	O ₂ 0.95
carbon dioxide	CO ₂ 0.81
hydrogen	H ₂ 3.80
argon	Ar 0.85
helium	He 2.70
propane	C ₃ H ₈ 0.80
nitrous oxide	N ₂ O 0.80

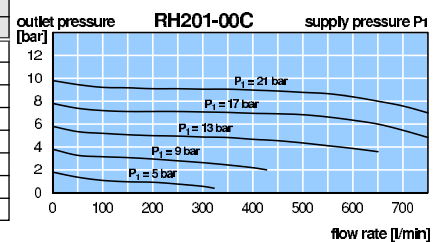

*1 Thread according to DIN 477, Part 1

*2 at supply pressure of 2x outlet pressure + 1 bar

only left hand thread is marked LH, right hand RH is not marked.

* Product group



Description	High pressure regulator for gas cylinders for reducing pressure of compressed air or liquid gases from a high level to the required pressure.
Supply pressure	max. 300 bar
Media	compressed air, oxygen or different gases
Connections	according to DIN 477 (Part 5)
Adjustment	by T-handle
Gauge port	All regulators are equipped with both one supply pressure gauge and one outlet pressure gauge.
Leakage rate	10 ⁻⁶ mbar l/s
Compensation	All regulators are equipped with supply pressure variation compensation, so that a change in supply pressure has no effect on the outlet pressure's stability.
Temperature range	-30 °C to 60 °C / -22 °F to 140 °F
Material	Body: brass O-rings: NBR/Buna-N and EPDM Spring cage: brass Diaphragm: 65NBR4550, PTFE for outlet > 10 bar, stainless steel for pure gases up to 5.0

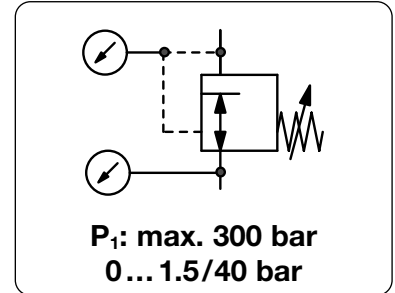

Dimensions			Version	Flow rate		Supply pressure	Pressure range	Order number
A	B	C	1-step	m ³ /h*2	l/min*2	max. bar	bar	
mm	mm	mm	2-step					

Cylinder pressure regulator 300 bar <small>for compressed air, connections DIN 477, with inlet / outlet gauges</small> RH300								
210	190	100	1-step	48	800	300	0 ... 10	RH301-00C
210	210	120		75	1250		0 ... 20	RH301-00D
				120	2000		0 ... 40	RH301-00E
240	190	100	2-step	8	133	300	0 ... 1,5	RH302-00A
				48	800		0 ... 10	RH302-00C



RH301, 1-step



Special options, change the appropriate letter

compressed air	connection gauge G ⁵ / ₈	RH35 -...-
carbon dioxide	CO ₂	RH30 -...-03
inert gas		RH30 -...-04
argon	Ar	RH30 -...-05
fuel gas		RH30 -...-06
nitrogen	N ₂	RH30 -...-07
forming gas		up to 40 bar RH30 -...-08
helium	He	up to 40 bar RH30 -...-09
hydrogen	H ₂	RH30 -...-11
testing gas		up to 40 bar RH30 -...-12
oxygen	O ₂	up to 20 bar RH30 -...-15
chrome-plated body	inside and outside	1-step RH301 -C....
chrome-plated body	inside and outside	2-step RH302 -C....
metal diaphragm	5.0 purity	1-step RH301 - .M...
		2-step RH302 - .M...

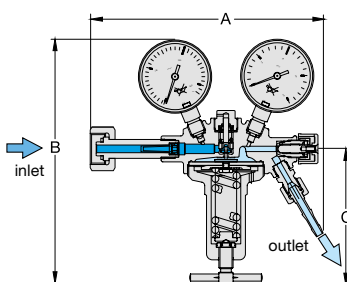

cross-section, 1-step

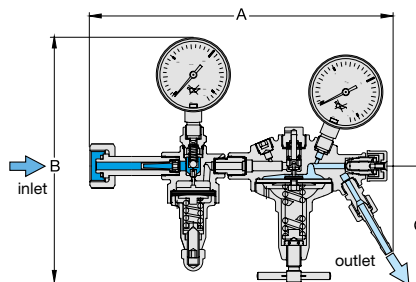

cross-section, 2-step



RH302, 2-step



RH301-C..., chrome-plated

connection thread up to 300 bar		
gas type	inlet *1	outlet
fuel gas	W30x2 LH	G ³ / ₄ LH
all others	W30x2	G ¹ / ₄

flow rate - correction factor	
gas type	factor
compressed air	1.00
oxygen O ₂	0.95
carbon dioxide CO ₂	0.81
hydrogen H ₂	3.80
argon Ar	0.85
helium He	2.70
propane C ₃ H ₈	0.80
nitrous oxide N ₂ O	0.80

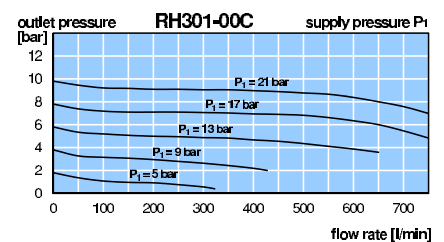

*1 Thread according to DIN 477, Only left hand thread is marked LH. Right hand RH is not marked.
*2 at supply pressure of 2x outlet pressure + 1 bar

* Product group

PDF CAD
www.aircom.net



Order example:
RH301-00C

MAIN PRESSURE REGULATOR UP TO 300 BAR

RH

Description	Main pressure regulator according to ISO 7291 up to 300 bar with G½ connection thread. A filter at the inlet port protects against contamination.
Media	compressed air, oxygen or different gases on request
Supply pressure	see chart, max. 300 bar
Connections	G¼ to G½
Adjustment	by T-handle for RH-..7.510 / 520 / 525 by hexagonal spindle (spanner size 20 mm) for RH-..7.545 / 565
Gauge port	All regulators are equipped with both one supply pressure gauge and one outlet pressure gauge.
Leakage rate	10 ⁻⁶ mbar l/s
Compensation	without supply pressure variation compensation
Temperature range	-30 °C to 60 °C / -22 °F to 140 °F
Material	Body: brass O-rings: NBR/Buna-N Spring cage: brass Diaphragm: 65NBR4550, stainless steel for oxygen > 20 bar

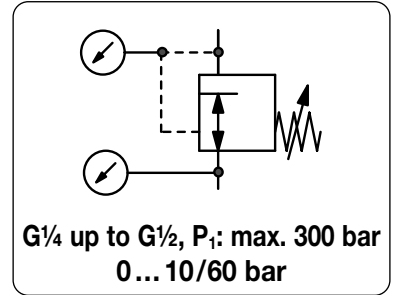

Dimensions			Flow rate	Supply pressure	Connection thread	Pressure range	Order number
A	B	C	m³/h*1	l/min*1	max. bar	bar	

Main pressure regulator					for compressed air, supply and outlet pressure gauge supplied	RH		
150	205	115	50	830	100	G½	0... 10	RH-147.510
			75	1250			0... 20	RH-147.520
200	310	215	170	2830			0... 20	RH-147.525
			290	4830			15... 40	RH-147.545
			450	7500			15... 60	RH-147.565
150	205	115	50	830	200	G½	0... 10	RH-247.510
			75	1250			0... 20	RH-247.520
200	310	215	170	2830			0... 20	RH-247.525
			290	4830			15... 40	RH-247.545
			450	7500			15... 60	RH-247.565
150	205	115	50	830	300	G½	0... 10	RH-347.510
			75	1250			0... 20	RH-347.520
200	310	215	170	2830			0... 20	RH-347.525
			290	4830			15... 40	RH-347.545
			450	7500			15... 60	RH-347.565



RH-47.510 / 520



RH-47.525 / 545 / 565

Special options, add the appropriate letter

G¼	connection thread, max. 100 bar	RH-. 27...
G¾	connection thread	RH-. 37...
metal diaphragm	5.0 purity	RH-. . 7... M
carbon dioxide	CO ₂	RH-. . 7... 03
inert gas		RH-. . 7... 04
argon	Ar	RH-. . 7... 05
fuel gas		up to 40 bar
nitrogen	N ₂	RH-. . 7... 06
forming gas		up to 40 bar
helium	He	RH-. . 7... 07
hydrogen	H ₂	RH-. . 7... 08
testing gas		up to 40 bar
methane	CH ₄	RH-. . 7... 09
natural gas *2		RH-. . 7... 10
oxygen	O ₂	up to 20 bar
chrome plated body	inside and outside	RH-. . 7... 11
		RH-. . 7... 12
		RH-. . 7... 13M
		RH-. . 7... 14
		RH-. . 7... 15
		RH-. . 7... C

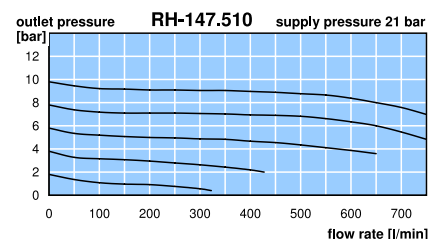
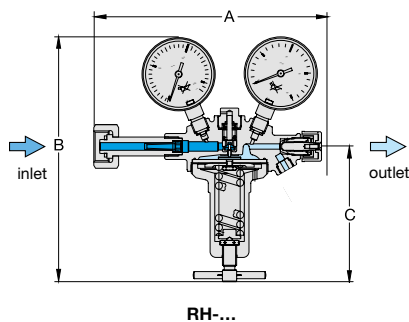

*1 at supply pressure of 2 x outlet pressure + 1 bar

*2 without DVGW-approval

* Product group

PDF CAD
www.aircom.net



Order example:
RH-147.510

MINIATURE HIGH PRESSURE REGULATOR UP TO 414 BAR

RH1

Description Diaphragm-operated high pressure regulator of small and light design.
Media compressed air, non-corrosive gases or liquids
Supply pressure max. 414 bar
Adjustment by black plastic knob
Relieving function non-relieving
Leakage rate $< 1 \times 10^{-4}$ mbar l/s He
Gauge port 1/4" NPT for inlet and outlet pressure
Weight aluminium 200 g, brass 430 g
Mounting position any
Temperature range -25 °C to 75 °C / -13 °F to 167 °F
Materials Body: nickel-plated aluminium
 Regulating system: piston with EPDM o-ring, as option NBR/Buna-N or FKM
 Valve seat: CTFE or Vespel as option
 Inner valve: stainless steel and aluminium

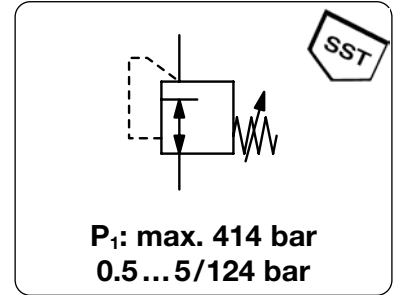

Dimensions			K _v -value (m³/h)	Flow rate m³/h	l/min	Connection thread NPT	Pressure range bar	Order number
A	B	C						

High pressure regulator 414 bar				for gases and liquids, non-relieving aluminium, piston with EPDM			RH1	
41	76	13	0.05	84*2	1400*1	1/4" NPT	0.5... 5	RH1-02A
							0.5... 10	RH1-02B
							1.5... 15	RH1-02C
41	76	13	0.05	192*3	3200*2	1/4" NPT	4.0... 48	RH1-02D
							8.0... 83	RH1-02E
							10...124	RH1-02F



RH1

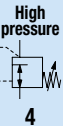

Special options, add the appropriate letter

Vespel seat		für RH1	RH1-02.X45
NBR o-ring		für RH1	RH1-02.N
FKM o-ring		für RH1	RH1-02.V
brass pressure gauge	inlet side		RH1-02.GM
SST pressure gauge	inlet side		RH1-02.G

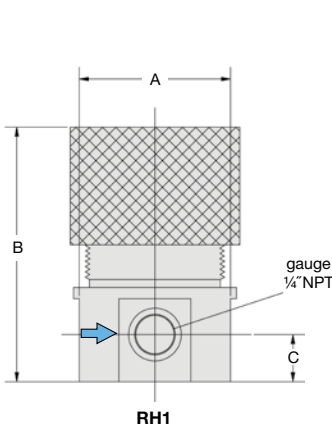

RH1

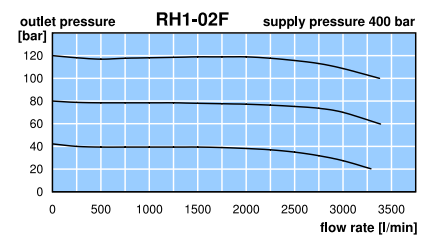
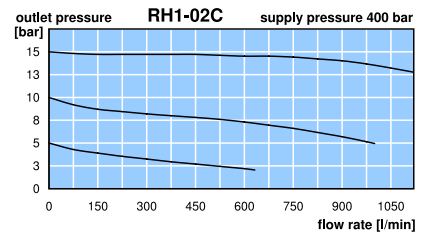
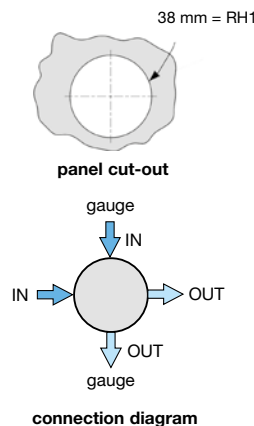

*1 at 400 bar supply pressure and 15 bar outlet pressure
 *2 at 400 bar supply pressure and 120 bar outlet pressure

* Product group

PDF CAD
 www.aircom.net



Order example:
 RH1-02A

HIGH PRESSURE REGULATOR FOR PURE GASES UP TO 207 BAR

RH2

Description	Diaphragm-operated high pressure regulator of small design and with high flow.		
Media	compressed air, non-corrosive gases or pure gases up to 5.0		
Supply pressure	max. 207 bar		
Test pressure	150 % of maximum supply pressure		
Leakage rate	< 2 x 10 ⁻⁸ mbar l/s He		
Adjustment	by black plastic knob		
Relieving function	non-relieving		
Gauge port	¼" NPT for inlet and outlet pressure, shifted by 60°		
Mounting position	any		
Temperature range	-40 °C to 75 °C / -40 °F to 167 °F		
Material	Body: brass or stainless steel 316	Spring cage: nickel-plated brass	
	Diaphragm: stainless steel 316	Seals: PTFE	
	Valve seat: CTFE	Inner valve: stainless steel 316	

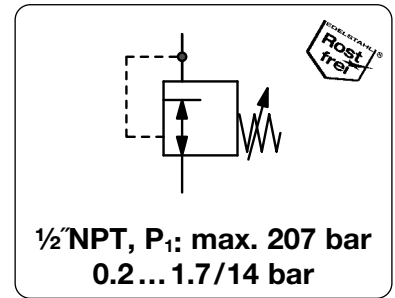

Dimensions			K _v -value (m³/h)	Flow rate		Connection thread NPT	Pressure range bar	Order number
A	B	C		m³/h*1	l/min*1			

Brass pressure regulator, ½" NPT							supply pressure max. 207 bar, non-relieving	RH2
66	150	26	0.9	330	5500	½" NPT	0.2... 1.7	RH2-04A
							0.2... 3.5	RH2-04B
							0.5... 7.0	RH2-04C
							1.0... 10	RH2-04D
							1.0... 14	RH2-04E



RH2

SST pressure regulator, ½" NPT							supply pressure max. 207 bar, non-relieving	RH2
66	150	26	0.9	330	5500	½" NPT	0.2... 1.7	RH2-04AS
							0.2... 3.5	RH2-04BS
							0.5... 7.0	RH2-04CS
							1.0... 10	RH2-04DS
							1.0... 14	RH2-04ES

Special options, add the appropriate letter

¾" NPT	connection thread		RH2-03.
brass pressure gauge	for brass body,	outlet side	RH2-0...GM
SST pressure gauge	for stainless steel body,	outlet side	RH2-0...G

Accessories, enclosed

mounting nut	for panel mounting, made of stainless steel	8686-1
--------------	---	--------

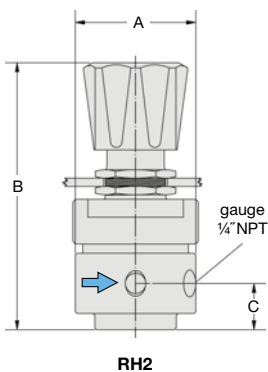

RH2

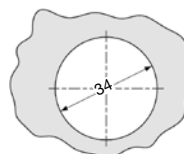

panel cut-out

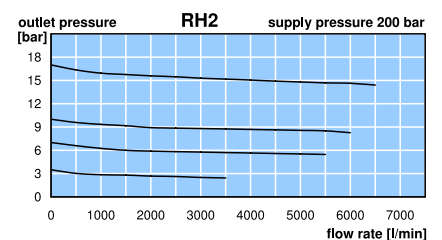

*1 at 200 bar supply pressure and 14 bar outlet pressure

* Product group

PDF CAD
www.aircom.net



Order example:
RH2-04A

HIGH PRESSURE REGULATOR UP TO 690 BAR

HP300 / HP400

Description	Piston-operated high pressure regulator HP300 / HP400 are marked by high flow and great reliability.	
Media	compressed air, non-corrosive gases or liquids	
Supply pressure	max. 690 bar at HP300, max. 414 bar at HP400	
Accuracy	at supply pressure variation of 7 bar: < 5 mbar pressure deviation at HP300, < 250 mbar pressure deviation at HP400	
Adjustment	by black plastic knob	
Relieving function	non-relieving, optionally relieving	
Mounting position	any	
Temperature range	-5 °C to 75 °C / 23 °F to 167 °F for HP300 -25 °C to 75 °C / -13 °F to 167 °F for HP400	
Material	Body:	brass, optionally stainless steel (spring cage brass), stainless steel completely on request
	Seals:	NBR at HP300 (relieving), FKM at HP300 (non-relieving) / HP400
	Spring cage:	brass at HP300, nickel-plated at HP400
	Valve seat:	Vespel at HP300 / HP400 (relieving), Teflon PFA at HP400 (non-relieving)
	Inner valve:	stainless steel
	Leakage rate	< 10 ⁻⁴ mbar l/s He
	Gauge port	1/4" NPT for inlet / outlet pressure, shifted by 70°

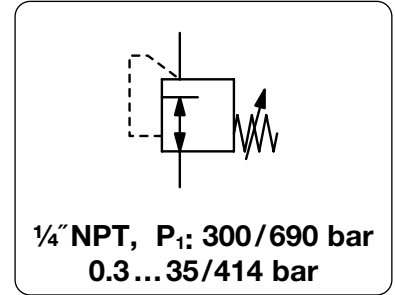

Dimensions			K _v -value (m ³ /h)	Flow rate m ³ /h*1 / l/min*1	Connection thread NPT	Pressure range bar	Order number
A	B	C					
mm	mm	mm					

High pressure regulator 414 bar							non-relieving, brass	HP300
55	175	19	0.05	90	1500	1/4" NPT	0.3 ... 35	HP300-035
							0.6 ... 55	HP300-055
							0.7 ... 104	HP300-105
							1.0 ... 172	HP300-175
							1.7 ... 276	HP300-280
							3.4 ... 414	HP300-415



High pressure regulator 414 bar							non-relieving, brass	HP400
50	137	13	0.05	90	1500	1/4" NPT	0.7 ... 104	HP400-104
							1.0 ... 172	HP400-170



Special options, add the appropriate letter		
relieving		HP300-...R HP400-...R
body made of SST	(690 bar) (414 bar)	HP300-...S HP400-...S
for oxygen	specially cleaned, P ₁ < 300 bar	for HP300/400 HP.00-...15
for liquids	w/o filter at inlet, valve seat of Nylatron w/o filter at inlet, valve seat of Vespel	for HP300 HP300-...W for HP400 HP400-...W
brass pressure gauge	for brass body, inlet side for brass body, outlet side	HP.00-...HM HP.00-...GM
SST pressure gauge	for stainless steel body, inlet side for stainless steel body, outlet side	HP.00-...H HP.00-...G

Accessories, enclosed		
set of mounting brackets	aluminium	for HP300 1129
mounting nut	for panel mounting, made of stainless steel	for HP400 8686-1

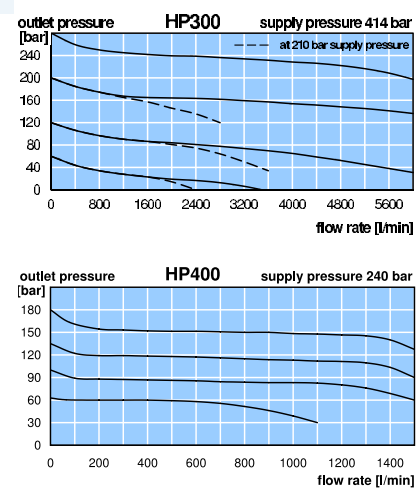
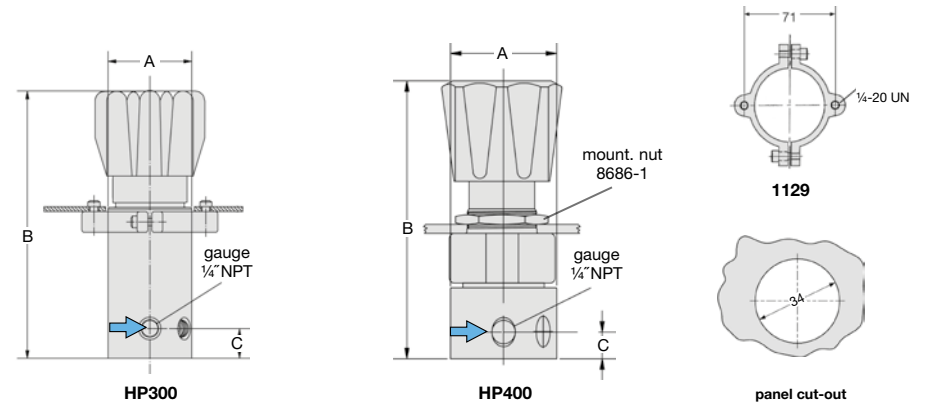

*1 at 240 bar supply pressure and 30 bar outlet pressure

* Product group

HIGH PRESSURE REGULATOR UP TO 300 BAR

HP500

Description	Piston-operated high pressure regulator HP500R and diaphragm-operated HP500 are marked by high flow and great reliability.	
Media	compressed air, non-corrosive gases or liquids	
Supply pressure	max. 300 bar	
Accuracy	at supply pressure variation of 7 bar: < 120 mbar pressure deviation	
Adjustment	by black plastic knob	Leakage rate < 2x 10 ⁻⁸ mbar l/s He
Relieving function	non-relieving, optionally relieving	Gauge port 1/4" NPT for inlet / outlet pressure, shifted by 70°
Mounting position	any	
Temperature range	-40 °C to 75 °C / -40 °F to 167 °F	
Material	Body: brass, optionally stainless steel (spring cage brass), stainless steel completely on request	
	Seals: FKM	
	Spring cage: nickel-plated	Valve seat: Teflon PFA
	Inner valve: stainless steel	Diaphragm: stainless steel

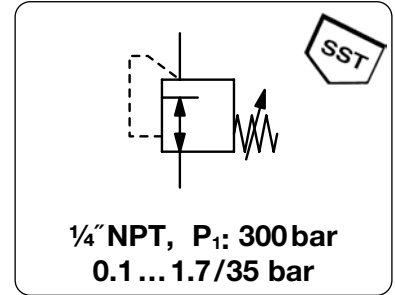

Dimensions			K _v -value	Flow rate		Connection thread	Pressure range	Order number
A	B	C	(m ³ /h)	m ³ /h*1	l/min*1	NPT	bar	D*

High pressure regulator 300 bar			non-relieving, brass	HP500				
50	137	19	0.05	90	1500	1/4" NPT	0.1 ... 1.7	HP500-002
							0.1 ... 3.5	HP500-004
							0.1 ... 7.0	HP500-007
							0.2 ... 17	HP500-017
							0.3 ... 35	HP500-035



HP500

Special options, add the appropriate letter

relieving		HP500-...R
body made of SST		HP500-...S
free of grease and oil	suitable for oxygen, P ₁ < 200 bar	HP500-...L
for liquids	w/o filter at inlet, valve seat of Vespel	HP500-...W
brass pressure gauge	for brass body, inlet side	HP500-...HM
	for brass body, outlet side	HP500-...GM
SST pressure gauge	for stainless steel body, inlet side	HP500-...H
	for stainless steel body, outlet side	HP500-...G

Accessories, enclosed

mounting nut	for panel mounting, made of stainless steel	8686-1
---------------------	---	--------

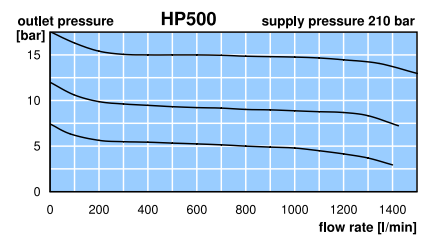
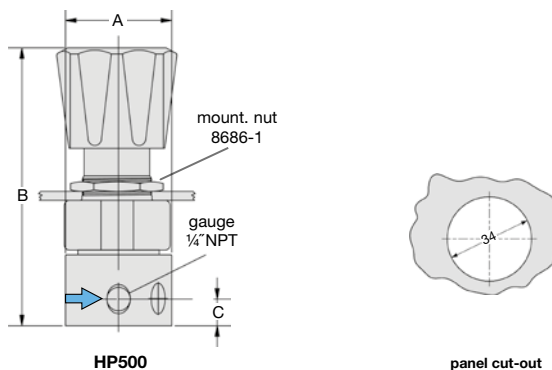

*1 at 240 bar supply pressure and 30 bar outlet pressure

* Product group

PDF CAD
www.aircom.net



Order example:
HP500-002

HIGH FLOW / HIGH PRESSURE REGULATOR UP TO 410 BAR

RH3

Description	High pressure regulator with high flow and high reliability. Large piston sensor for high sensitivity and balanced stem design for constant downstream pressure.	
Media	compressed air, non-corrosive gases or liquids	
Supply pressure	max. 260 bar, optionally up to 310 bar or 410 bar	
Leakage rate	< 1 x 10 ⁻⁴ mbar l/s He	
Adjustment	by black plastic knob	
Relieving function	relieving, optionally non-relieving	
Gauge port	none, optionally 1/4" NPT for inlet and outlet	
Mounting position	any	
Temperature range	-25 °C to 100 °C / -13 °F to 212 °F	
Material	Body: brass, optionally stainless steel	O-rings: NBR/Buna-N and FKM
	Main valve seat: CTFE, PTFE at RH3-04B	Relieving valve: CTFE, PTFE at RH3-04B/-04C
	Inner valve: PTFE and brass, optionally stainless steel	

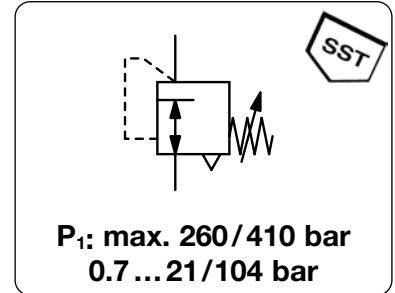

Dimensions			K _v -value (m ³ /h)	Flow rate m ³ /h*1 l/min*1	Connection thread NPT	Pressure range bar	Order number
A	B	C					
mm	mm	mm					

High pressure regulator 260 bar, 1/2" NPT							relieving, brass	RH3
76	203	45	1.7	420	7000	1/2" NPT	0.7 ... 21	RH3-04B
							1.0 ... 42	RH3-04C
							1.4 ... 70	RH3-04D
							3.4 ... 104	RH3-04E

Special options, add the appropriate letter

3/4" NPT	connection thread		RH3-06
non-relieving	without relieving function		RH3-0 . .K
stainless steel, 310 bar	body: stainless steel 316		RH3-0 . .S1
stainless steel, 410 bar	body: stainless steel 316, add. pre. range 3.4 ... 172 bar (F)		RH3-0 .S2
brass, 345 bar	body: brass, add. pre. range 3.4 ... 172 bar (F)		RH3-0 .U
gauge port	1/4" NPT for inlet and outlet		RH3-0 .M
brass pressure gauge	inlet side MHM	outlet side	RH3-0 . .MGM
SST pressure gauge	inlet side MH	outlet side	RH3-0 . .MG



RH3

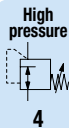

Accessories, enclosed

set of mounting brackets	for panel mounting	1129
--------------------------	--------------------	------

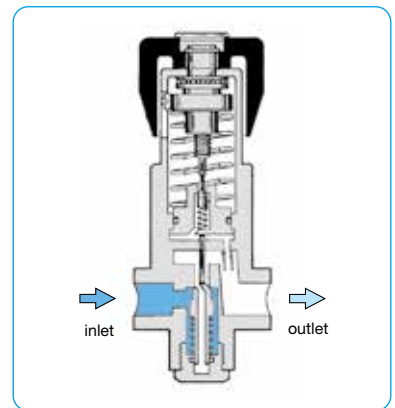

cross-section

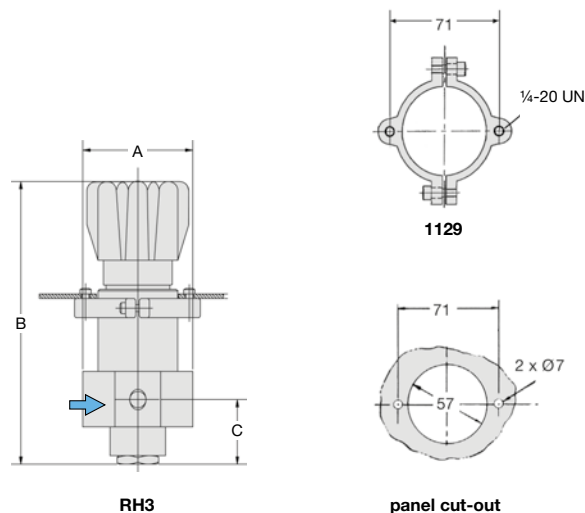

RH3

panel cut-out

gauge port, option "M"

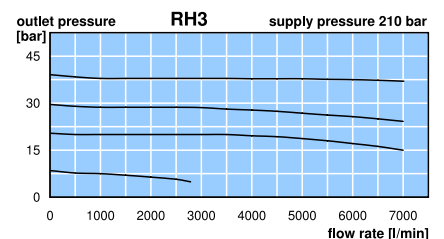
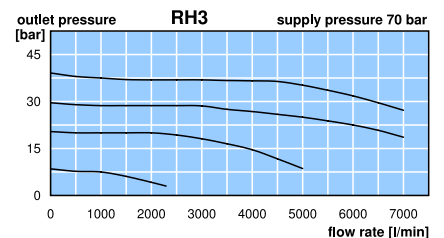

*1 at 210 bar supply pressure and 40 bar outlet pressure

* Product group



HIGH PRESSURE REGULATOR UP TO 414 BAR

RH4

Description	High pressure regulator with balanced valve design ensuring stable downstream pressure. Excellent for low pressure.		
Media	compressed air, non-corrosive gases or liquids		
Supply pressure	max. 414 bar		
Exhaust	for compressed air or gases: 1/4" NPT tapped exhaust for inlet and outlet		
Leakage	bubble-tight		
Adjustment	by black plastic knob, optionally pneumatical control through diaphragm or piston		
Relieving function	for compressed air or gases: relieving for liquids: non-relieving		
Gauge port	non, optionally 1/4" NPT for inlet and outlet		
Mounting position	any		
Temperature range	-26 °C to 74 °C / -15 °F to 165 °F		
Weight	2.2 kg		
Material	Body: brass, optionally 316 stainless steel	O-rings: NBR/Buna-N, on request FKM, Kalrez, E.P.	
	Main valve seat: Vespel SP21	Relieving valve: Vespel SP21	
	Inner valve: Monel, stainless steel	Filter: bronze, 40 µm, only for liquids	

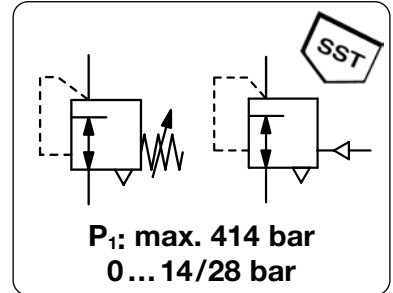

Dimensions			K _v -value	Flow rate	Connection thread	Pressure range	Order number
A	B	C	(m ³ /h)	m ³ /h*1	NPT	bar	
mm	mm	mm		l/min*1			D*

High pressure regulator 414 bar							brass body, Vespel SP21, NBR/Buna-N relieving, without gauge port	RH4
76	159	19	0.3	510	8500	3/8" NPT	0 ... 14	RH4-03A
							0 ... 28	RH4-03B
						1/2" NPT	0 ... 14	RH4-04A
							0 ... 28	RH4-04B



RH4-...S

Special options, add the appropriate letter

booster version	1/2" NPT, 0...41 bar, brass, diaphragm control, P _{St} = 5.8 bar	RH4-04J1
	piston control	RH4-04J2
non-relieving	without relieving function	RH4-0..K
stainless steel body		RH4-0..S
gauge port	1/4" NPT for inlet and outlet	RH4-0..M
brass pressure gauge	inlet side MHM	outlet side RH4-0..MGM
SST pressure gauge	inlet side MH	outlet side RH4-0..MG

Accessories, enclosed

mounting nut for panel mounting 62634

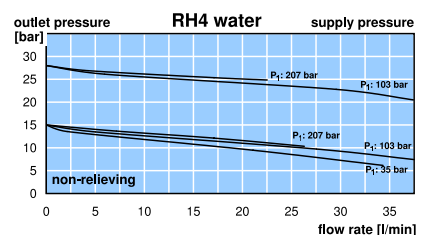
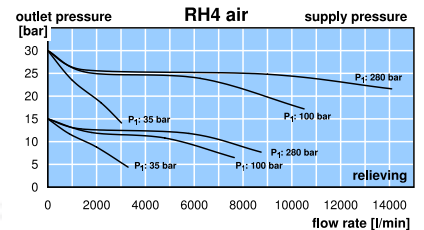
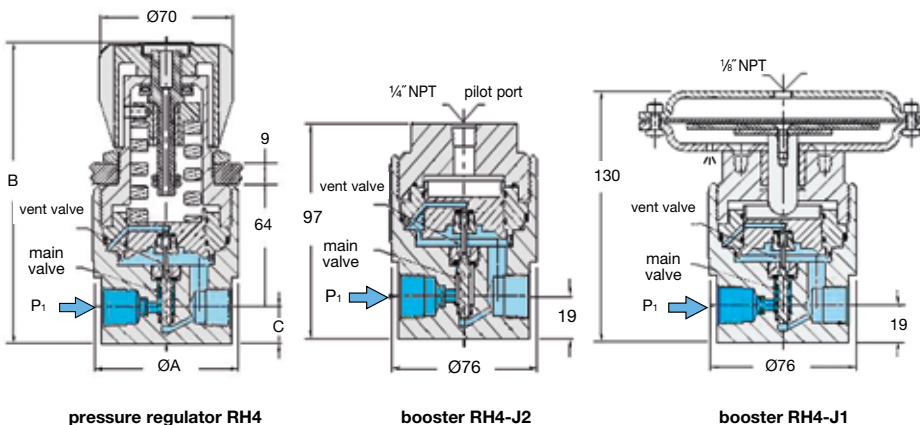
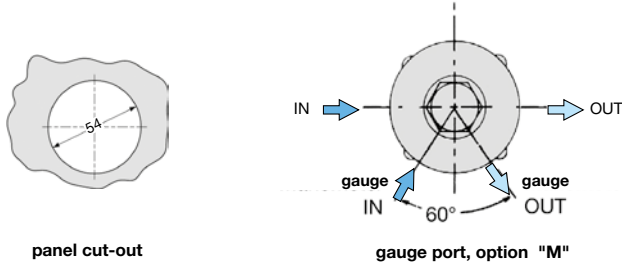

*1 at 280 bar supply pressure and 14 bar outlet pressure

* Product group

PDF CAD
www.aircom.net



Order example:
RH4-03A

HIGH PRESSURE REGULATOR

HP306

Description	High pressure regulator, piston operated, made of stainless steel, with high sensitivity, excellent accuracy and reliability.		
Media	compressed air and non-corrosive gases or liquids (non-relieving version)		
Supply Pressure	max. 690 bar optionally 415 bar or 1034 bar		
Accuracy	at supply pressure variation of 7 bar: < 100 mbar		
Adjustment	by black plastic adjustment dial		
Relieving Function	standard relieving, optional non-relieving		
Gauge Ports	no ports, optional 1/4" NPT for inlet and outlet pressure, shifted by 60°		
Temperature Range	-40° to 75°C / -40°F to 167°F		
Material	Body: stainless steel 316	Mounting position: any	
	Seal: NBR optional FKM	Spring Cage: stainless steel 300	
	Valve Seat: Vespel	Filter: 40 µm, stainless steel 300, brass by option U	
	Inner Valve: stainless steel 300	Relieving Valve: CTFE	

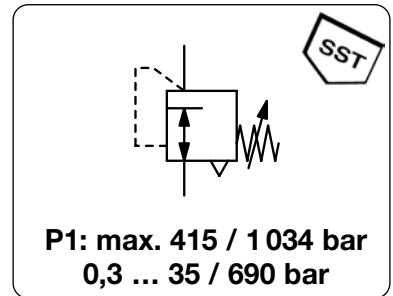

Dimensions			K _v -value (m³/h)	Flow rate m³/h*1	Flow rate l/min*1	Connection thread NPT	Pressure range bar	Order Number
A	B	ØC						

High Pressure Regulator 690 bar			relieving, compressed air, stainless steel, NBR		HP306		
55	175	19	0,05	210	3600	1/4" NPT 0.3 ... 35	HP306-035
				230	3900	1/4" NPT 0.3 ... 55	HP306-055
				280	4800	1/4" NPT 0.7 ... 105	HP306-105
				320	5400	1/4" NPT 1.0 ... 175	HP306-175
				390	6500	1/4" NPT 1.7 ... 275	HP306-280
				420	7000	1/4" NPT 3.4 ... 415	HP306-415
				450	7500	1/4" NPT 14 ... 690	HP306-690



Special options, add the appropriate letter

3/8" NPT	connection thread	HP306-...03
1/2" NPT	connection thread not possible by option S	HP306-...04
FKM elastomer		HP306-...V
non-relieving	with FKM elastomer	HP306-...VK
for oxygen	special cleaned, P1 < 200 bar	HP306-...15
inlet pressure 415 bar	brass up to pressure range 3.4 ... 415	HP306-...U
inlet pressure 1034 bar	stainless steel	HP306-...S
tapped exhaust	with FKM elastomer, 1/4" NPT	HP306-...VX12
gauge port	1/4" NPT for inlet and outlet	HP306-...M
gauge brass	inlet side MHM	HP306-...MGM
gauge stainless steel	inlet side MH	HP306-...MG

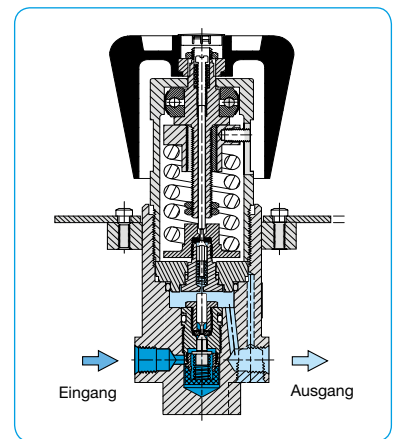

Accessories, enclosed

monting bracket	made of aluminium	1129
-----------------	-------------------	------

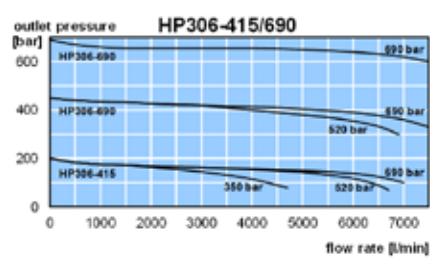
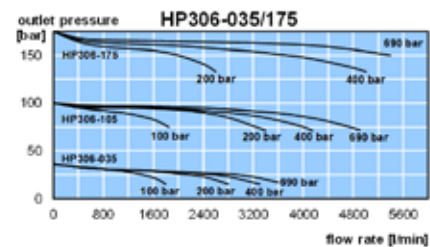
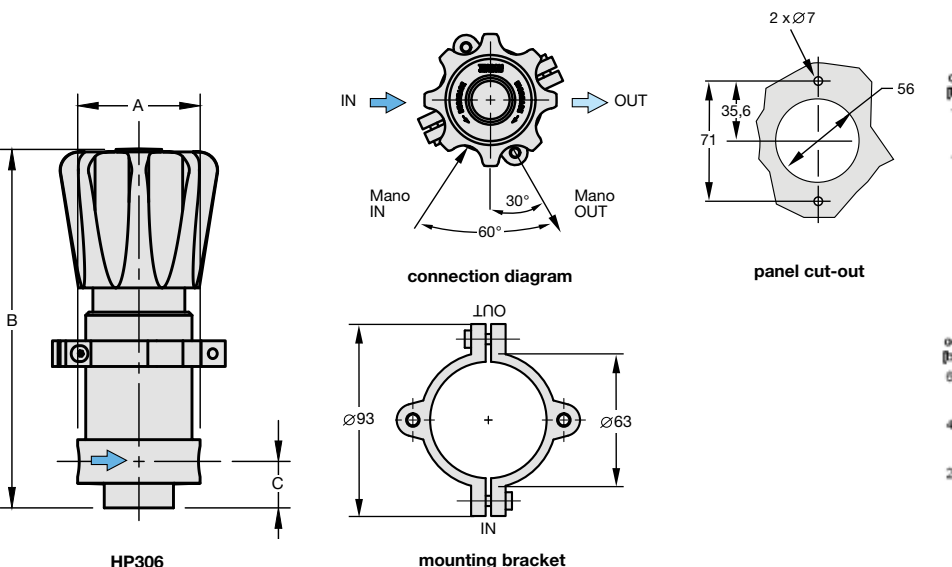

*1 at 690 bar inlet pressure, see diaphragm

* Product group

DIFFERENTIAL PRESSURE REGULATOR P1: MAX. 414 BAR, P2: 0-103 BAR

RH44

Description	The dome loaded, spring biased regulator is designed for pressure tracking applications to maintain a constant differential pressure. Venting allows for pressure tracking increases and decreases.		
Media	compressed air or gases according to the selected material		
Supply pressure	max. 414 bar	Outlet pressure	max. 103 bar
Exhaust	tapped exhaust 1/4" NPT	Control port	1/8" NPT
Adjustment	hexagonal screw for spring tension	Leakage	bubble-tight
Gauge port	not available	Mounting position	any
Temperature range	-26 °C to 74 °C / -14 °F to 165 °F		
Material	Body:	brass, optionally stainless steel 302	
	Valve seat and gasket:	CTFE, Vespel	
	O-Rings:	FKM	

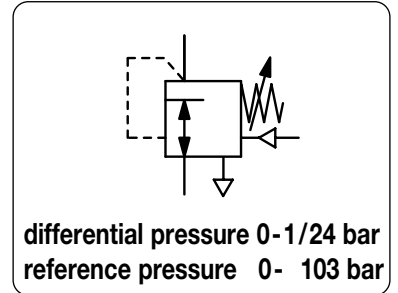

Dimensions			K _v -value (m³/h)	Flow rate l/min*1	Connection thread NPT	Differential pressure range bar	Order number
A mm	B mm	C mm					

Differential pressure regulator								P ₁ max: 414 bar, P _A max: 103 bar, brass relieving, P _s : 0 ... 103 bar, FKM / CTFE	RH44
76	212	46	0.7	10000	1/2" NPT	0... 1 bar	RH44-04A		
						0... 7 bar	RH44-04B		
						0... 14 bar	RH44-04C		
						0... 24 bar	RH44-04D		
76	212	46	2.0	21000	3/4" NPT	0... 1 bar	RH44-06A		
						0... 7 bar	RH44-06B		
						0... 14 bar	RH44-06C		
						0... 24 bar	RH44-06D		

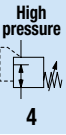

Special options, add the appropriate letter

body stainless steel RH44-0..S

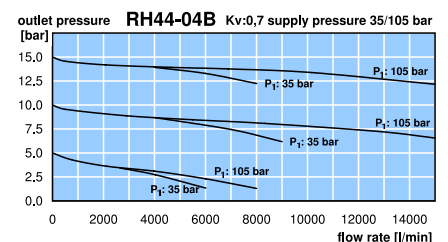
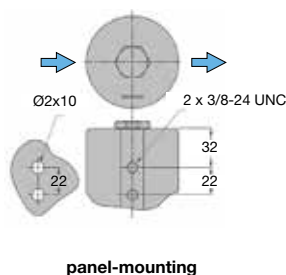
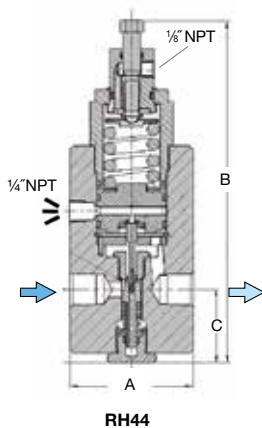
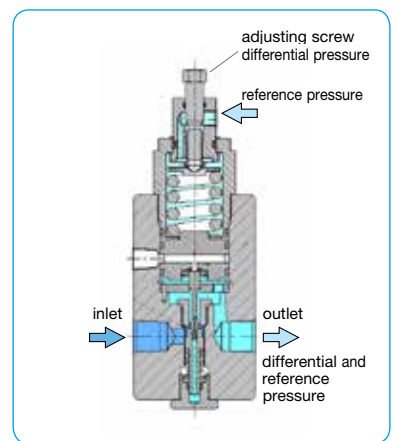
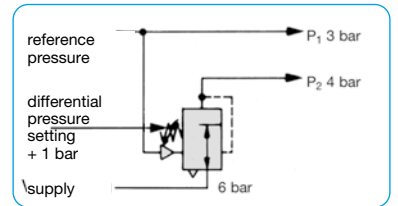

*1 bei P₁ = 105 bar, P₂ = 15 bar and Δp = 1 bar

* Product group

Stainless steel version: see chapter for stainless steel devices

PDF CAD
www.aircom.net

Order example:
RH44-04A